

**YOUR TRUSTED PARTNER
FOR PRODUCTIVE SAFETY**



CHS Controls AB
Tel +46 42 38 61 00, Fax +46 42 38 61 29
chs@chscontrols.se www.chscontrols.se





Message from the President and CEO

Having started this company over twenty years ago, I still feel that same passion today that drove me forward in those early years - building a lasting company that rests on a firm foundation of excellence, innovation and creativity. The same teamwork, trust, and integrity that brought us this far is the catalyst for helping us participate in building a better and safer workplace for tomorrow. Today's ideas are the seeds that will sprout into the next great workplace safety innovation. I thank you for your business and being a part of our vision in building a safer workplace.

– Phil Allen

Our Story

In the 1990s, Grace was challenged to find a better way of safely accessing an electrical panel at a John Deere facility. The team at Grace created a solution for thru-door access, which birthed the GracePort® — a fully customizable convenience data port that allows access to live control cabinets through closed doors. Since 1993, the GracePort® has become a household name among control engineers. It was the first product that Grace developed that keeps voltage away from workers.

With the advent of the GracePort®, Grace began to hit its stride as a pioneer in the electrical safety industry. In the 2000s, innovation met efficiency with SafeSide® Permanent Electrical Safety Devices (PESD) with the primary goal of protecting people and their assets. Today, as we continue to globally expand our products and services, the concept of PESD is rapidly evolving and setting a new standard in the electrical safety industry.

These powerful, yet intensely practical ideas provide Grace with a firm foundation and a solid cornerstone as we move forward. The birth of this idea started as a mere workaround to safely access the inside of a live control cabinet. This idea has grown into an innovative business model that has propelled Grace to become a global leader in electrical safety.

“For it is by grace you have been saved, through faith – and this is not from yourselves, it is the gift of God – not by works, so that no one can boast.” *Ephesians 2:8-9*

Business Philosophy

We have an “easy to do business with” goal at Grace Engineered Products. Regardless if you are a customer, distributor, or vendor, we strive to be the easiest company you do business with. Period.

As a Christian company, we employ Christian principals in our business practices. We endeavor to be good stewards by managing the resources God has blessed us with in a manner that will glorify Him.



CHS Controls AB
Tel +46 42 38 61 00, Fax +46 42 38 61 29
chs@chscontrols.se www.chscontrols.se

Our Vision

Driving innovative solutions, enhancing productivity, keeping people safe and assets secure through simple and affordable solutions.

Our Mission – Productive Safety

- Pursue practical ways of keeping voltage away from workers — before, during and after maintenance tasks.
- Enhance worker's productivity as they feel confidently-safer when performing equipment maintenance.
- Help customers protect their people and equipment from the damaging effects of electrical energy.
- Educate customers with our solutions and compliance issues in minimizing their risks.

Our Values

- Fostering Innovation
- Embracing Change
- Streamlining Business
- Demonstrating Integrity
- Exemplifying God

Our Brands

GracePort®

GracePorts® are a foundational tool many facilities use across the globe to keep people away from voltage. GracePorts® are fully customized communication ports that allow workers to access control panels easily through closed doors.



Our SafeSide® brand includes Permanent Electrical Safety Devices like voltage indicators, voltage portals and combo units. All of these are tools that allow for maintenance and/or inspection safely from outside the electrical cabinet.



CHS Controls AB
Tel +46 42 38 61 00, Fax +46 42 38 61 29
chs@chscontrols.se www.chscontrols.se

HUMPDAY

About HumpDay

As the leading innovator in Permanent Electrical Safety Devices (PESD), we're all about keeping people away from live voltage.

We care deeply for people and our weekly blog is a way we like to stay connected and give a break to those in our industry and beyond with what's new at Grace, tidbits of fun, giveaways, and of course, electrical safety.

Subscribe to HUMPDAY and join the conversation!

Join the fun and get the electrical safety info you need! Check out our Blog at info.graceport.com/blog

www.graceport.com

NEW

See pg. 29 for details

GracePort®

WE'VE GOT YOU COVERED

WITH THE NEW GRACEPORT®+
LARGE HOUSING

KEEP PEOPLE SAFE AND ASSETS SECURE

WITH GRACEPORT®+. Our NEW GracePort®+ HMI cover kit is UL Recognized and complements our custom line of GracePort® components conveniently installed in this large protected housing. The formed-in-place polyurethane gasket provides a reliable seal that protects HMI equipment and electronics from environmental contaminants.

HMI's not included.
Components are fully customizable.



Actual product certification will vary with component selection.



CHS Controls AB
Tel +46 42 38 61 00, Fax +46 42 38 61 29
chs@chscontrols.se www.chscontrols.se

GracePort®



CATALOG



CHS Controls AB
Tel +46 42 38 61 00, Fax +46 42 38 61 29
chs@chscontrols.se www.chscontrols.se

GracePorts® are communication ports that allow workers to access control panels easily through closed doors, which eliminates the risk of contamination to the panel. Thru-door access enhances compliance to NFPA 70E / CSA Z462 as well as global electrical safety standards. Our ability to fully customize your GracePort® to meet your precise needs means never having to compromise safety.

Welcome to GracePorts®

A Guide to Customizing Your GracePort®	7
Top 24 GracePort® Configurations	8
Components	10
Computer and PLC Interfaces	11
Other Common Connections	14
Manufacturer-Specific Components	17
Non-Manufacturer-Specific Components	19
Housing Size and UL Ratings	21
Power / Circuit Breaker	31
Customize	35
GracePort® FAQs	38

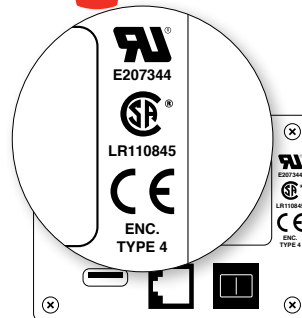

Definitions



UL: UL provides safety-related certification, validation, testing, inspection, auditing, advising and training services to a wide range of clients, including manufacturers, retailers, policymakers, regulators, service companies, and consumers.

UL is one of several companies approved to perform safety testing by the US federal agency Occupational Safety and Health Administration (OSHA). OSHA maintains a list of approved testing laboratories, which are known as Nationally Recognized Testing Laboratories.



CSA: CSA test products for compliance to national and international standards, and issue certification marks for qualified products. Certification marks tell customers and users that a product has been evaluated by a formal process—involving examination, testing and follow-up inspection—and that it complies with applicable standards for safety and performance.



CE: The CE Mark on a product or machine identifies it as complying with all the of safety requirements established by the European Union. The CE Mark is a requirement and not a voluntary process.

UL 508: Since the GracePort® products are UL recognized a UL 508 shop must have the product item number or at least the UL CCN NITW2 in their UL file. The customer must contact UL to add information to their UL file.

Please note the following:

The GracePorts® are referred to as*:

- UL TYPE 1
- UL TYPE 3R
- UL TYPE 4
- UL TYPE 4X
- UL TYPE 12

**This is only if the faceplate is marked with UL. If not marked with UL logo then the product has no UL rating.*

A Guide to Customizing Your GracePort®

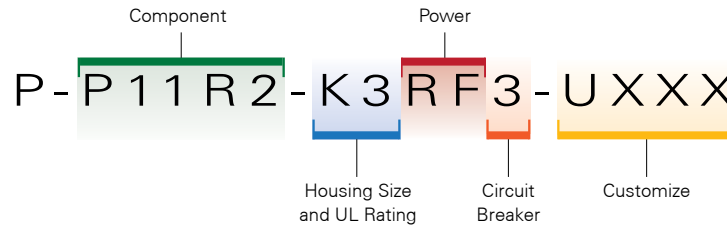

Customize

Customizing your GracePort® means you can get exactly what you need...no more, no less. The Customize section in our part number layout allows customers to specify additional needs including special text, logos, cable lengths and hole cut-outs. This section is located after the second dash in our part number layout: P-P11R2-K3RF3-**UXXX**

Components

There are various connectors available and are represented by a 2- to 3-digit code found in between the first two dashes of our GracePort® part number layout. Multiple connectors in a GracePort® are listed alpha-numerically, as seen here:

P-**P11R2**-K3RF3-UXXX

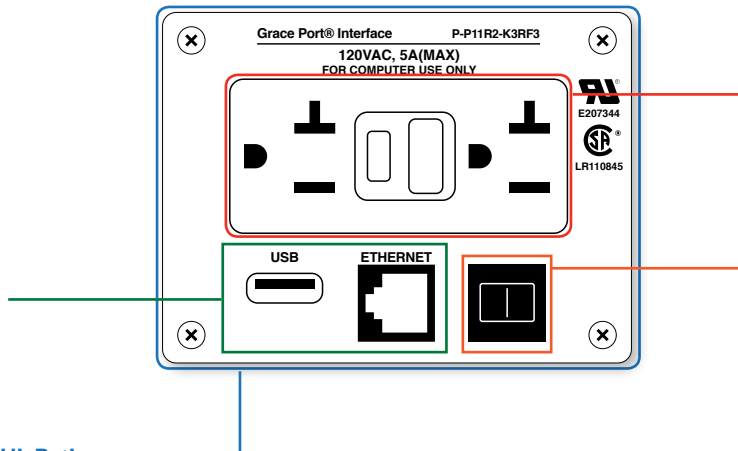

Power Option / Circuit Breaker

Many power options for international and domestic use are available and are represented by a one to two or three letter code. Because circuit breakers offer the ability to limit what devices can be run through the GracePort®, we offer different amperages, which is represented by the amperage number following the power option code. P-P11R2-K3**RF3**-UXXX

Housing Size & UL Rating

Several housing types are available to meet your needs. The size of your housing depends on several variables including the kinds of components you choose, the power option you want and, in some cases, the UL rating you need. Housings include UL Type 1, 3R, 4, 4X, 12, stainless steel options, large housings and hazardous location housings. The code for the housing size and UL rating is represented in our example by a letter/number combination: P-P11R2-**K3**RF3-UXXX

Need to protect
HMI's and
other valuable
components?

See the NEW
GracePort®+
on pg. 29



800.280.9517

7

www.graceport.com



CHS Controls AB
Tel +46 42 38 61 00, Fax +46 42 38 61 29
chs@chscontrols.se www.chscontrols.se

Top 24 GracePort® Configurations



P-P11-B3RX

(1) Type A USB Female to Male with 10' cable in a UL Type 4 Housing, no Outlet



P-R2-F2R0

(1) Ethernet (RJ45), in a UL Type 4X Housing, with Simplex Outlet



P-R2-H3R3

(1) Ethernet (RJ45), 3 amp CB, in a UL Type 4 Housing, with Simplex Outlet



P-Q7-B3RX

(1) DB-9 Male - Female, in a UL Type 4 Housing, no Outlet



P-A14-F3R0

(1) MicroLogix 8-pin mini-din/Female to 8-pin mini-din/Male with 10' cable in a UL Type 4 Housing, with Simplex Outlet



P-R2-K2RF0

(1) Ethernet (RJ45), in a UL Type 4X Housing, with Inside-Outlet®



P-R2-B3RX

(1) Ethernet (RJ45) in a UL Type 4 Housing, no Outlet



P-R2-F3R0

(1) Ethernet (RJ45) in a UL Type 4 Housing, Simplex Outlet



P-R2-K2RF3

(1) Ethernet (RJ45), 3 amp CB, in a UL Type 4X Housing, with Inside-Outlet®



P-R2#2-B3RX

(2) Ethernet (RJ45) in a UL Type 4 Housing, no Outlet



P-R2-F3R3

(1) Ethernet (RJ45), 3 amp CB, in a UL Type 4 Housing, with Simplex Outlet



H-RF0-K3

UL Type 4 Housing with Inside-Outlet®

**P-P11R2-K3RF0**

(1) Type A/USB Female to Type A/USB Male with 10' Cable, Ethernet (RJ45) in a UL Type 4 Housing, with Inside-Outlet®

**P-R62-K3RF0**

(1) Category 6 Ethernet Bulkhead, in a UL Type 4 Housing, with Inside-Outlet®

**P-R62-M3RF0**

(1) Category 6 Ethernet Bulkhead, in a UL Type 4 Housing, with Inside-Outlet®

**P-R2-K3RF0**

(1) Ethernet (RJ45) in UL Type 4 Housing with Inside-Outlet®

**P-XX-K3RD0**

UL Type 4 Housing, with a Duplex non-GFCI Outlet

**P-R2-M3RF3**

(1) Ethernet (RJ45), 3 amp CB, in a UL Type 4 Housing, with Inside-Outlet®

**P-R2-K3RF3**

(1) Ethernet (RJ45), 3 amp CB, in a UL Type 4 Housing, with Inside-Outlet®

**P-R2-M3RA0**

(1) Ethernet (RJ45), in a UL Type 4 Housing, Australian Outlet

**P-E5-M3RF3**

Ethernet Switch, 3 amp CB, in a UL Type 4 Housing, with Inside-Outlet®

**P-R2-K3RF5**

(1) Ethernet (RJ45), 5 amp CB, in a UL Type 4 Housing, with Inside-Outlet®

**P-R2-M3RF0**

(1) Ethernet (RJ45), in a UL Type 4 Housing, with Inside-Outlet®

**P-R2-M5RF0**

(1) Ethernet (RJ45), in a UL Type 4X #304 Stainless Steel Housing, with Inside-Outlet®



COMPONENTS

Varieties of components are available and can be paired together in your fully customizable GracePort®. Whether you need something as common as an RJ45 or as unique as a DVI female-to-female feed-thru bulkhead, Grace Engineered Products can design and create a GracePort® that fits your precise need.





CHS Controls AB
Tel +46 42 38 61 00, Fax +46 42 38 61 29
chs@chscontrols.se www.chscontrols.se



DESCRIPTION	TYPE	GENDER FRONT	GENDER BACK	CONNECTOR CODE
-------------	------	--------------	-------------	----------------

Computer and PLC Interfaces

Ethernet & Network Interfaces



Category 5e Ethernet	Bulkhead	RJ45Female	RJ45Female	 R2
Category 5e Shielded	Bulkhead	RJ45Female	RJ45Female	R33
Category 6 Ethernet	Bulkhead	RJ45Female	RJ45Female	R62
Ethernet Switch (5 ports) <i>A 5-port unmanaged Ethernet switch provides simple communication between Ethernet devices. Diagnostics limited to the LEDs, you must be able to see the LEDs to diagnose communication problems. Our dual inside-out design allows you to see the status of each port from the inside and outside the panel.</i>	Unmanaged	RJ45Female (1)	RJ45Female (4)	 E5

Keyboard, Mouse & Monitor

DVI F/F (DVI-I, D, A)	Bulkhead	Female	Female	 Q102
Keyboard (PS/2)	Cable	6MDINFemale	6MDINMale	P3
Keyboard (USB)	Cable	USBAFemale	USBAMale	P28
Modem	Bulkhead	RJ12Female	RJ12Female	P7
Mouse (PS/2)	Cable	6MDINFemale	6MDINMale	P5
Mouse (USB)	Cable	USBAFemale	USBAMale	P29
VGA Monitor	Cable	HDDB15Female	HDDB15Male	 P6



DESCRIPTION	TYPE	GENDER FRONT	GENDER BACK	CONNECTOR CODE
-------------	------	--------------	-------------	----------------

Parallel Pin-to-Pin Extension Cables

8 Pin MiniDIN	Cable	8MDINFemale	8MDINMale	 R8
8 Pin MiniDIN Locking	Cable	8MDINFemale	8MDINMale	R28
DB15 F/M	Cable	DB15Female	DB15Male	R11
DB15 M/F	Cable	DB15Male	DB15Female	R10
DB15HDM F/M (Not for VGA)	Cable	Female	Male	R45
DB15HDM M/F (Not for VGA)	Cable	Male	Female	R44
DB25 F/M	Cable	DB25Female	DB25Male	 P2
DB25 M/F	Cable	DB25Male	DB25Female	R9
DB9 F/M	Cable	DB9Female	DB9Male	R3
DB9 M/F	Cable	DB9Male	DB9Female	P1

Serial, Parallel

DB25 Parallel	Cable	DB25Female	DB25Male	P2
DB25 Serial	Cable	DB25Male	DB25Female	P9
DB9 Serial	Cable	DB9Male	DB9Female	P1

DESCRIPTION	TYPE	GENDER FRONT	GENDER BACK	CONNECTOR CODE
Universal Serial Bus USB 4 to 1 Hub <i>USB Technology – USB compatibility 1.1 and 2.0; Connectors Types A and B high retention. Power – Source 5 VDC from USB Host; Downstream power provides 100mA per port to power downstream USB devices.</i>	Bulkhead	USB-AFemale	USB-BFemale	 P43
USB Memory Stick <i>Recessed USB Flash drive holder with cable. Maintain your rating with the ability to insert your flash drive and close the lid while your program runs. Maximum flash drive dimensions = 2.25"L x 0.68"W x 0.35"L.</i>	Cable	USB-AFemale	USB-AMale	 FRONT BACK P50
USB Mini Type B 5 POS	Cable	USB-BFemale	USB-BMale	 FRONT BACK P42
USB Type A/B F/F	Bulkhead	USB-AFemale	USB-BFemale	Q50
USB Type A-A Cable <i>USB 2.0 cable Type A female to Type A male. The female connector is on the front of the GracePort®.</i>	Cable	USB-AFemale	USB-AMale	 FRONT BACK P11
USB Type A-A F/F	Bulkhead	USB-AFemale	USB-AFemale	P22
USB Type B/A F/F	Bulkhead	USB-BFemale	USB-AFemale	Q51
USB Type B/B F/F	Bulkhead	USB-BFemale	USB-BFemale	P27
USB Type B/B M/M	Bulkhead	USB-BMale	USB-BMale	P31
USB Type B/F to USB Type B/M (6' integrated cable)	Cable	USB-BFemale	USB-BMale	P15

DESCRIPTION	TYPE	GENDER FRONT	GENDER BACK	CONNECTOR CODE
-------------	------	--------------	-------------	----------------

Other Common Connections



Banana Jacks

Black Banana Jack (sheathed)	Bulkhead	Female	Solder Terminal	Q85
Black Banana Jack (unsheathed)	Bulkhead	Female	Solder Terminal	Q75
Green Banana Jack (sheathed)	Bulkhead	Female	Solder Terminal	Q86
Green Banana Jack (unsheathed)	Bulkhead	Female	Solder Terminal	Q76
Red Banana Jack (sheathed)	Bulkhead	Female	Solder Terminal	Q84
Red Banana Jack (unsheathed)	Bulkhead	Female	Solder Terminal	Q74

Connector to Terminal Block PCB

DB9F (PCB Pins 1-9 to Terminal Block)	Term	DB9Female	Terminal Block	R1
DB9M (PCB Pins 1-9 to Terminal Block)	Term	D9Male	Terminal Block	R12
RJ-45 (PCB Pins 1-8 to Terminal Block)	Term	RJ45Female	Terminal Block	R15







Data Switch



DB9F 2:1	Custom	Female	Female	 <p>FRONT</p>  <p>BACK</p> <p>R38</p>
DB9F 4:1	Custom	Female	Female	R39
DB15 2:1	Custom	Female	Female	R47
DB15 4:1	Custom	Female	Female	R48
Crossover – Generic DB9F	Custom	Qty (2) DB9	–	R49
VGA 2:1	Custom	Female	Female	R102
50 OHM BNC 2:1	Custom	Female	Female	R101

DESCRIPTION	TYPE	GENDER FRONT	GENDER BACK	CONNECTOR CODE
Generic Bulkhead Interfaces				
4MDIN F/F	Bulkhead	Female	Female	Q26
50 ohm BNC	Bulkhead	Female	Female	 Q42
6MDIN F/F	Bulkhead	Female	Female	Q28
75 ohm Bulkhd, Feed-Thru, Coaxial F/F (non BNC)	Bulkhead	Female	Female	 Q40
8MDIN F/F	Bulkhead	Female	Female	Q29
DB-15 F/F	Bulkhead	Female	Female	Q35
DB-15 F/M	Bulkhead	Female	Male	Q37
DB-15 M/F	Bulkhead	Male	Female	 FRONT  BACK Q38
DB-15 M/M	Bulkhead	Male	Male	Q36
DB-15HD F/F	Bulkhead	Female	Female	Q18
DB-15HD F/M	Bulkhead	Female	Male	Q11
DB-15HD M/F	Bulkhead	Male	Female	Q12
DB-15HD M/M	Bulkhead	Male	Male	Q19
DB-15HDVGA F/F	Bulkhead	Female	Female	 Q22
DB-15HDVGA F/M	Bulkhead	Female	Male	Q24

DESCRIPTION	TYPE	GENDER FRONT	GENDER BACK	CONNECTOR CODE
-------------	------	--------------	-------------	----------------

Generic Bulkhead Interfaces (continued)

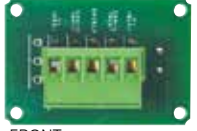
DB-15HDVGA M/F	Bulkhead	Male	Female	 FRONT  BACK Q23
DB-15HDVGA M/M	Bulkhead	Male	Male	Q25
DB-25 F/F	Bulkhead	Female	Female	 Q4
DB-25 F/M	Bulkhead	Female	Male	Q8
DB-25 M/F	Bulkhead	Male	Female	 FRONT  BACK Q10
DB-25 M/M	Bulkhead	Male	Male	Q16
DB-9 F/F	Bulkhead	Female	Female	Q3
DB-9 F/M	Bulkhead	Female	Male	Q7
DB-9 M/F	Bulkhead	Male	Female	 FRONT  BACK Q9
DB-9 M/M	Bulkhead	Male	Male	Q15
RJ-11/12 F/F	Bulkhead	Female	Female	Q6
RJ-45 F/F	Bulkhead	Female	Female	Q17
S-Video F/F	Bulkhead	Female	Female	Q26

DESCRIPTION	TYPE	GENDER FRONT	GENDER BACK	CONNECTOR CODE
Manufacturer-Specific Components				
Allen-Bradley (Rockwell Automation)				
A-B FlexLogix	Cable	DB9Male	DB9Female	A17
A-B SLC 500 DH-485	Bulkhead	RJ45Female	RJ45Female	B14
AIC+ Port 2	Cable	8 MDIN-Female	8 MDIN-Male	A13
CompactLogix	Cable	DB9Male	DB9Female	A16
ControlLogix	Cable	DB9Male	DB9Female	A8
DeviceNet (8A Max)	Term	5RTBMale	Terminal Block	 <p>FRONT</p>  <p>BACK</p> <p>D4</p>
MicroLogix (Series C)	Cable	8 MDIN-Female	8 MDIN-Male	A14
MicroLogix 1500-LRP (DB-9)	Cable	DB9Male	DB9Female	A18
PanelView (Serial)	Cable	DB9Male	DB9Female	A5
PLC-5 Channel 0 (DB-25)	Cable	DB25Female	DB25Male	A11
PowerFlex	Cable	8 MDIN-Female	8 MDINMale-lock	A19
PowerFlex 40,400	B/H Cable	RJ45Female	RJ45Male	A20
SCANport	Cable	8 MDIN-Female	8 MDINMale-lock	A10
SLC 500 DH-485 (20' Cable)	Term	RJ45Female	RJ45Male	B1
SLC-500 Channel 0	Cable	DB9Male	DB9Female	A12



DESCRIPTION	TYPE	GENDER FRONT	GENDER BACK	CONNECTOR CODE
-------------	------	--------------	-------------	----------------

Allen-Bradley (Rockwell Automation) (continued)



ControlNet

A-B ControlNet (20' Cable)	B/H Cable	RJ45Female	RJ45Male	B10
ControlNet (75 Ohm BNC tap)	Term	BNCFemale	BNCFemale	B7
ControlNet RJ-45 (20' Cable)	Term	RJ45Female	RJ45Male	B4

Crossover Switch

MicroLogix 1000, 1200, 150LSP to PanelView 300 Micro	Custom	Qty (2) DB9	-	 <p>FRONT</p>  <p>BACK</p> <p>R53</p>
MicroLogix 1500 LRP, SLC, PLC5, Control Logix, Compact Logix, Flex Logix to PanelView(+) 300-1500	Custom	Qty (2) DB9	-	R55
MicroLogix 1500 LRP, SLC, PLC5, Control Logix, Compact Logix, Flex Logix to PanelView 300 Micro	Custom	Qty (2) DB9	-	R54

Data Highway

DH+ / Remote I/O	Term	3RTBMale	Terminal Block	B6
DH+ Combo (DB9/8MDIN)	Term	8MDIN/DB9Female	Terminal Block	 <p>FRONT</p>  <p>BACK</p> <p>B9</p>

DESCRIPTION	TYPE	GENDER FRONT	GENDER BACK	CONNECTOR CODE
-------------	------	--------------	-------------	----------------

GE

GE Fanuc (340 SNP, 9/30)	Cable	DB15Female	DB15Male	G2
GE Fanuc Genius	Cable	DB9Male	DB9Female	G1

Mitsubishi

Mitsubishi USB Mini Type B 5 POS	Cable	Female	Male	P42
Mitsubishi A Series PLC	Cable	DB25Female	DB25Male	M11
Mitsubishi FX Series PLC	Cable	8MDINFemale	8MDINMale	M10
Mitsubishi Q-Series PLC	Cable	6MDINFemale	6MDINMale	M13

Schneider

Micro, E284-258/265/275/285	P/O	DB9Female	RJ-45	M7
ModBus (Serial-Extension Cable Version)	Cable	DB9Female	DB9Male	M8
ModBus Plus	Cable	DB9Female	BLUNT	M6
ModBus Plus Industrial Tap	Term	RJ-45	Terminal Block	M4
Modicon ModBus Plus Tap	Term	RJ-45	Terminal Block	D4
Momentum	Cable	DB9Female	RJ45Male	M17
Momentum (Peripheral Port)	Cable	RJ45Female/Female	RJ45Male	M16
Schneider Automation - FIPWay	Term	DB9Female	Terminal Block	M9
Telemecanique UniTelway 8MDIN Locking Cable	Cable	8MDINFemale	8MDINMale	M5

Siemens

Siemens Micro-Master	Cable	DB15Female	DB15Male	H6
Siemens Simatic 545-(1103,1104,1105,1106), 555-(1103,1104,1105,1106), 575-(2104,2105,2106)	Cable	DB9Female	DB9Male	H5

Non-Manufacturer-Specific Components

DL05,06,105,205,D3-350,D4-450 CPU Ports	Cable	DB15HD-Female	Male	M22
DL06, D2-250 Bottom Port	B/H Cable	RJ-11Female/Female	Male	M20
DL340/CPU Ports	B/H Cable	RJ-12Female/Female	Male	M21
DL405 CPU/Bottom/DCM, DL305 w/DCU RS232	Cable	DB25-Female	Male	M24
DL405 Port CPU, DL405 SLICE I/O	Cable	DB15-Female	Male	M23
Omron CS/CJ/CQ Peripheral Port (Use Omron Programming Cable)	Bulkhead	DB9Female	DB9Male	M15
Omron Serial (DB9)	Cable	DB9Male	DB9Female	M14

HOUSING SIZE AND UL RATINGS

Whether you need 304 or 316 Stainless Steel, Surface Mount, or our Thru-View® panel mount housing, our housings are all UL rated.



CHS Controls AB
Tel +46 42 38 61 00, Fax +46 42 38 61 29
chs@chscontrols.se www.chscontrols.se



UL Type 4

Either indoor or outdoor use to provide a degree of protection against falling rain, splashing water and hose-directed water; undamaged by the formation of ice on the enclosure.

Thru-View® Housing: From the smallest B-size to the largest M-size.



UL Type 4X

Either indoor or outdoor use to provide a degree of protection against falling rain, splashing water and hose-directed water; undamaged by the formation of ice on the enclosure; resists corrosion.

Thru-View® Housing: Designed to maintain enclosure integrity, this Thru-View housing lets you "see" inside the cabinet without opening the panel door.

Stainless Steel Housing: Keep stainless steel enclosures closed and maintain panel integrity with our 100% stainless steel housings available in both Type 304 and 316. See page 24.



UL Type 12

Indoor use to provide a degree of protection against dust, dirt, fiber flyings, dripping water and external condensation of noncorrosive liquids.

Thru-View® Housing: From the smallest B-size to the largest M-size, this is our most commonly used of the Thru-View® series.



UL Type 3R

Outdoor use to provide a degree of protection against falling rain; undamaged by the formation of ice on the enclosure.

Thru-View® Housing: Designed for wet or damp locations, In-use extra-duty housings allow items to be plugged in while the cover is closed, which offers protection against rain and moisture.



UL Type 1

Indoor use primarily to provide protection against contact with the enclosed equipment and against a limited amount of falling dirt.

Panel mount, no housing

Panel Mount UL Type 4-IP65

Housing Code	Weight (oz)	MOUNTING DIMENSIONS (inches [mm])					OVERALL DIMENSIONS (inches [mm])							
		A	B	C	D	ER	F	G	H	I	J	K	LR	MR
B3	3.8	2.06±.010 [52.4±.2]	1.42±.010 [36.0±.2]	2.76±.004 [70.0±.1]	1.26±.004 [32.0±.1]	.18+.010 [4.5+.2]	3.15 [80.0]	1.72 [43.6]	3.20 [81.2]	1.60 [40.7]	4.33 [110.1]	.96 [24.4]	N/A	.18±.004 [4.5±.1]
F3	5.1	3.36±.010 [85.4±.2]	1.42±.010 [36.0±.2]	4.03±.004 [102.4±.1]	1.26±.004 [32.0±.1]	.18+.010 [4.5+.2]	4.45 [113.0]	1.72 [43.6]	3.20 [81.2]	1.60 [40.7]	4.87 [123.7]	.57 [14.4]	N/A	.18±.004 [4.5±.1]
H3	5.9	4.42±.010 [112.4±.2]	1.42±.010 [36.1±.2]	5.12±.004 [130.0±.1]	1.26±.004 [32.0±.1]	.18+.010 [4.5+.2]	5.51 [140.0]	1.72 [43.6]	3.20 [81.2]	1.60 [40.7]	4.87 [123.7]	.57 [14.4]	N/A	.18±.004 [4.5±.1]
K3	10.8	3.39±.010 [86.0±.2]	2.91±.010 [74.0±.2]	4.41±.004 [112.0±.1]	2.76±.004 [70.0±.1]	.26+.010 [6.5+.2]	5.08 [129.0]	3.54 [90.0]	4.79 [121.6]	1.60 [40.7]	8.28 [210.2]	.45 [11.4]	.45 [11.5]	.26±.004 [6.5±.1]
M3	13.2	4.80±.010 [122.0±.2]	3.15±.010 [80.0±.2]	5.83±.004 [148.0±.1]	2.76±.004 [70.0±.1]	.26+.010 [6.5+.2]	6.50 [165.0]	3.78 [96.0]	5.02 [127.6]	1.60 [40.7]	8.52 [216.4]	.57 [14.4]	.45 [11.5]	.26±.004 [6.5±.1]

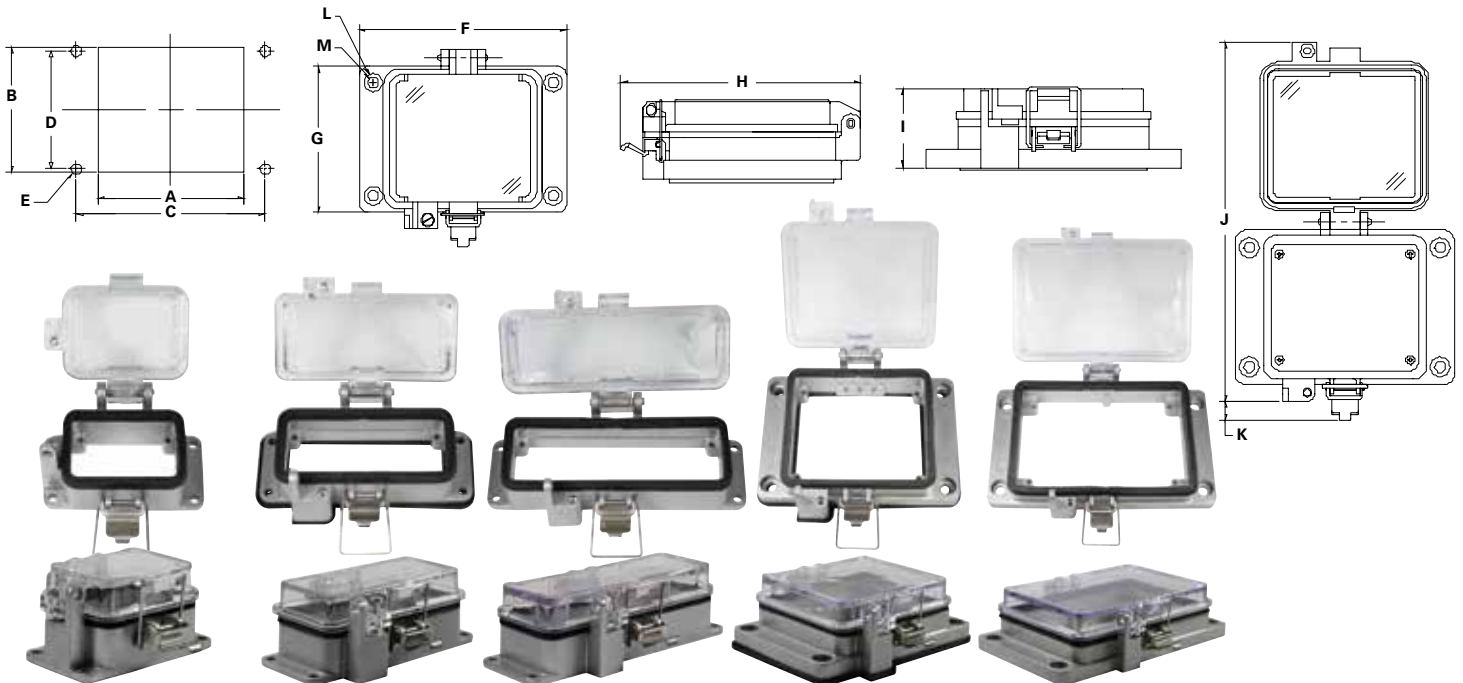

Housing Code: B3

Housing Code: F3

Housing Code: H3

Housing Code: K3

Housing Code: M3

Panel Mount UL Type 4X-IP65

Housing Code	Weight (oz)	MOUNTING DIMENSIONS (inches [mm])					OVERALL DIMENSIONS (inches [mm])							
		A	B	C	D	E \bar{R}	F	G	H	I	J	K	L \bar{R}	M \bar{R}
B2	3.8	2.06±.010 [52.4±.2]	1.42±.010 [36.0±.2]	2.76±.004 [70.0±.1]	1.26±.004 [32.0±.1]	.18±.010 [4.5±.2]	3.15 [80.0]	1.72 [43.6]	3.20 [81.2]	1.60 [40.7]	4.33 [110.1]	.96 [24.4]	N/A	.18±.004 [4.5±.1]
F2	5.1	3.36±.010 [85.4±.2]	1.42±.010 [36.0±.2]	4.03±.004 [102.4±.1]	1.26±.004 [32.0±.1]	.18±.010 [4.5±.2]	4.45 [113.0]	1.72 [43.6]	3.20 [81.2]	1.60 [40.7]	4.87 [123.7]	.57 [14.4]	N/A	.18±.004 [4.5±.1]
H2	5.9	4.42±.010 [112.4±.2]	1.42±.010 [36.1±.2]	5.12±.004 [130.0±.1]	1.26±.004 [32.0±.1]	.18±.010 [4.5±.2]	5.51 [140.0]	1.72 [43.6]	3.20 [81.2]	1.60 [40.7]	4.87 [123.7]	.57 [14.4]	N/A	.18±.004 [4.5±.1]
K2	10.8	3.39±.010 [86.0±.2]	2.91±.010 [74.0±.2]	4.41±.004 [112.0±.1]	2.76±.004 [70.0±.1]	.26±.010 [6.5±.2]	5.08 [129.0]	3.54 [90.0]	4.79 [121.6]	1.60 [40.7]	8.28 [210.2]	.45 [11.4]	.45 [11.5]	.26±.004 [6.5±.1]
M2	13.2	4.80±.010 [122.0±.2]	3.15±.010 [80.0±.2]	5.83±.004 [148.0±.1]	2.76±.004 [70.0±.1]	.26±.010 [6.5±.2]	6.50 [165.0]	3.78 [96.0]	5.02 [127.6]	1.60 [40.7]	8.52 [216.4]	.57 [14.4]	.45 [11.5]	.26±.004 [6.5±.1]

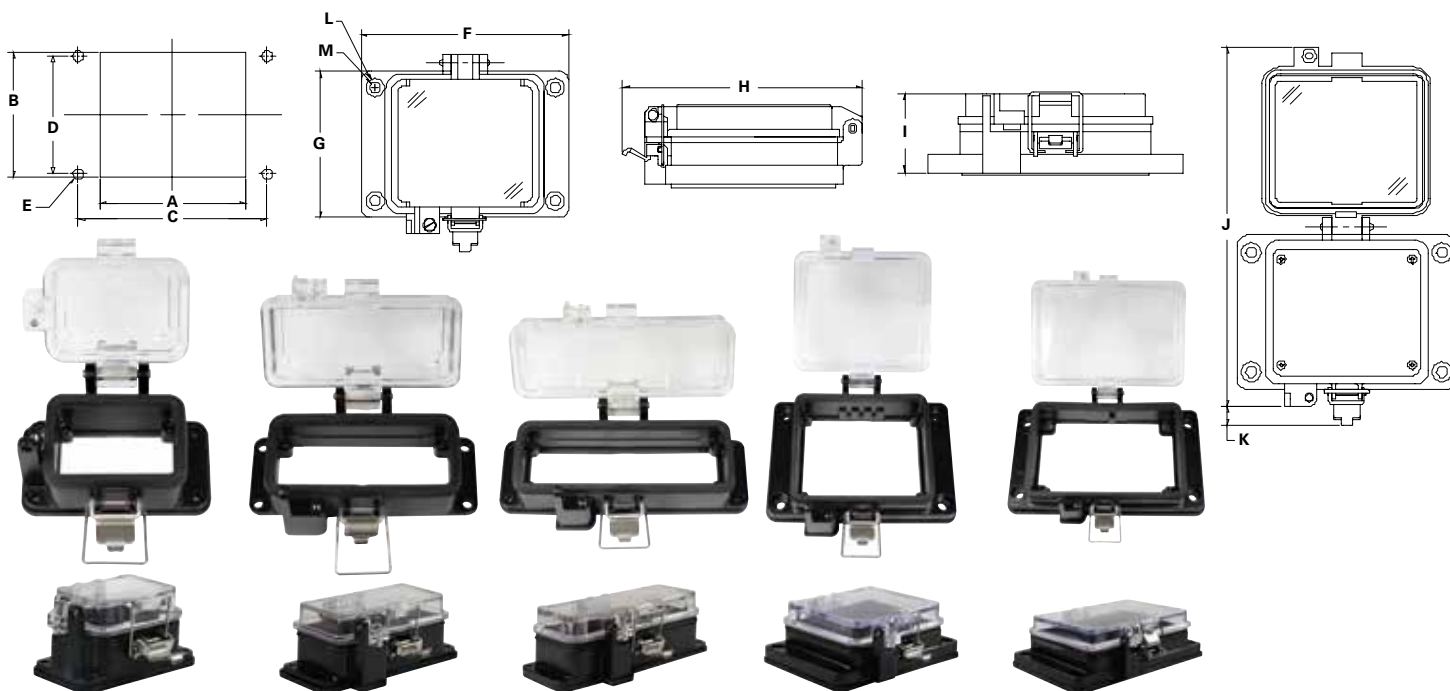

Housing Code: B2

Housing Code: F2

Housing Code: H2

Housing Code: K2

Housing Code: M2

Panel Mount UL Type 12-IP65 Rating

Housing Code	Weight (oz)	MOUNTING DIMENSIONS (inches [mm])					OVERALL DIMENSIONS (inches [mm])							
		A	B	C	D	E \bar{R}	F	G	H	I	J	K	L \bar{R}	M \bar{R}
B4	3.8	2.06±.010 [52.4±.2]	1.42±.010 [36.0±.2]	2.76±.004 [70.0±.1]	1.26±.004 [32.0±.1]	.18±.010 [4.5±.2]	3.15 [80.0]	1.72 [43.6]	3.20 [81.2]	1.60 [40.7]	4.33 [110.1]	.96 [24.4]	N/A	.18±.004 [4.5±.1]
F4	5.1	3.36±.010 [85.4±.2]	1.42±.010 [36.0±.2]	4.03±.004 [102.4±.1]	1.26±.004 [32.0±.1]	.18±.010 [4.5±.2]	4.45 [113.0]	1.72 [43.6]	3.20 [81.2]	1.60 [40.7]	4.87 [123.7]	.57 [14.4]	N/A	.18±.004 [4.5±.1]
H4	5.9	4.42±.010 [112.4±.2]	1.42±.010 [36.1±.2]	5.12±.004 [130.0±.1]	1.26±.004 [32.0±.1]	.18±.010 [4.5±.2]	5.51 [140.0]	1.72 [43.6]	3.20 [81.2]	1.60 [40.7]	4.87 [123.7]	.57 [14.4]	N/A	.18±.004 [4.5±.1]
K4	10.8	3.39±.010 [86.0±.2]	2.91±.010 [74.0±.2]	4.41±.004 [112.0±.1]	2.76±.004 [70.0±.1]	.26±.010 [6.5±.2]	5.08 [129.0]	3.54 [90.0]	4.79 [121.6]	1.60 [40.7]	8.28 [210.2]	.45 [11.4]	.45 [11.5]	.26±.004 [6.5±.1]
M4	13.2	4.80±.010 [122.0±.2]	3.15±.010 [80.0±.2]	5.83±.004 [148.0±.1]	2.76±.004 [70.0±.1]	.26±.010 [6.5±.2]	6.50 [165.0]	3.78 [96.0]	5.02 [127.6]	1.60 [40.7]	8.52 [216.4]	.57 [14.4]	.45 [11.5]	.26±.004 [6.5±.1]

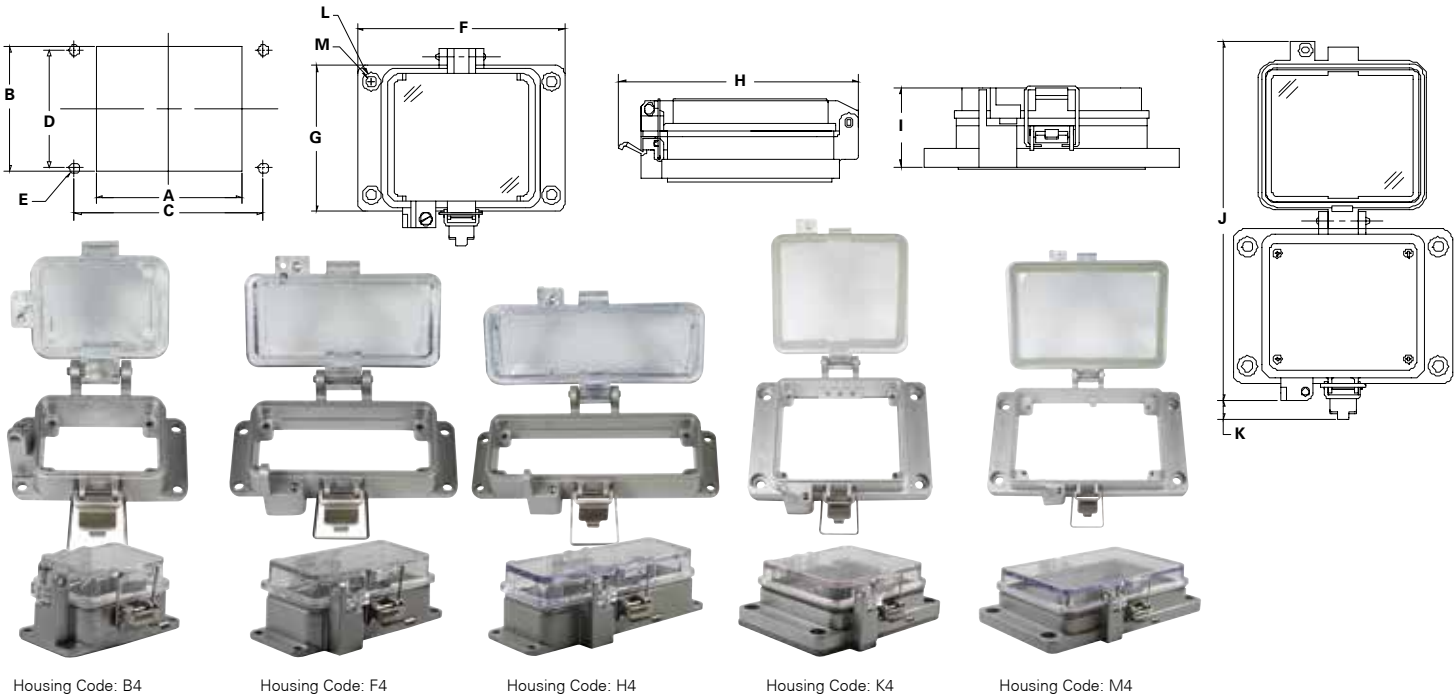

Extra-Duty Weather Resistant M8 UL Type 3R Panel Mount In-Use Housing

Housing Code	MOUNTING DIMENSIONS (inches [mm])					OVERALL DIMENSIONS (inches [mm])					
	A	B	C	D	E	F	G	H	I	J	K
M8	4.80±.010 [122.0±0.2]	3.15±.010 [80.0±0.2]	5.83±.004 [148.0±0.1]	2.76±.004 [70.0±0.1]	.26±.010 [6.50±0.3]	6.50 [165.0]	3.78 [96.0]	5.02 [127.6]	4.59 [116.7]	9.03 [229.4]	0.57 [14.4]

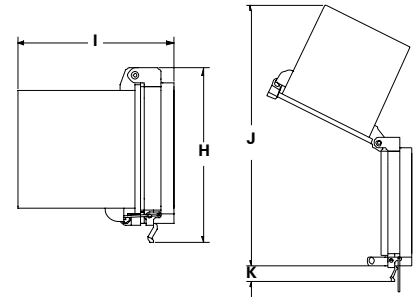
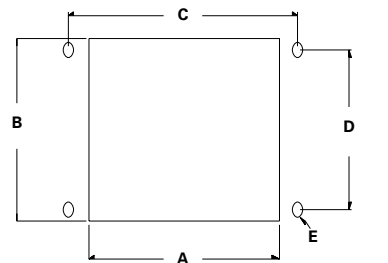

Housing Code: M8

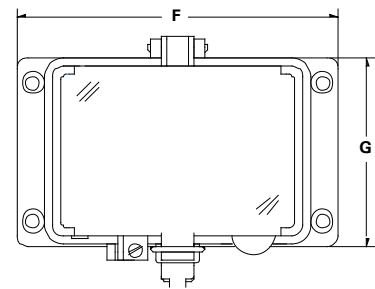
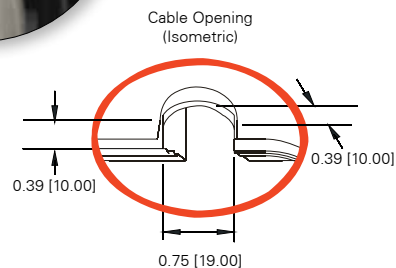

GracePort® Thru-Door Clean Panel Interface UL Type 1

GracePort® UL Type 1 Panels bring connections complete with cables or bulkhead connectors to the outside of your panels. Choose from our standard sizes and interfaces or a custom interface to fit your exact requirements. Custom printing text and logos add value to your application.

Units can be built with gasketing to offer an extra measure of protection against dust and other contaminants. If you want a gasket included, add a -G to the end of the part number.

We offer quick delivery of connector plate interface panels from our huge inventory of cables, connectors and bulkhead connectors.

HOUSING ENVIRONMENT	SIZE: (H x W, INCHES)	UL TYPE
B1	1.72 x 3.15	1
F1	1.72 x 4.45	1
H1	1.72 x 5.51	1
K1	3.54 x 5.08	1
M1	3.79 x 6.50	1
S1	Custom panel	1

Need something special? Your custom is our standard!

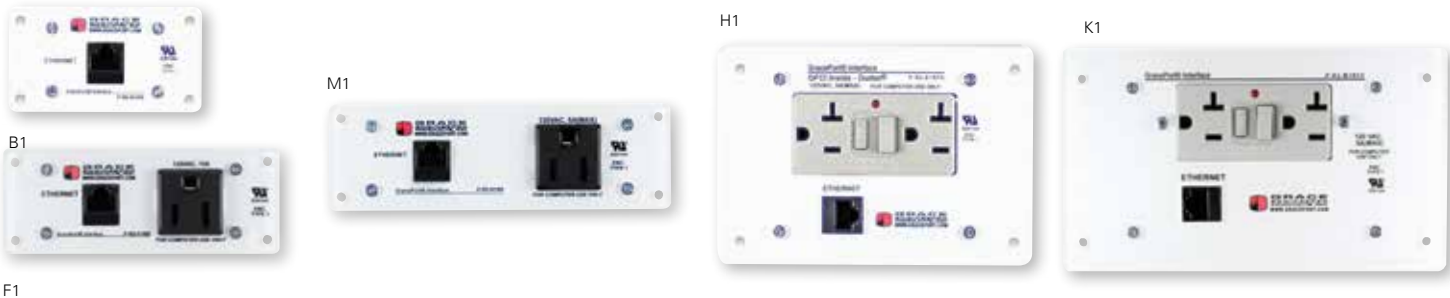

Other interfaces are also available

GracePort® Hazardous Location Housing

The **Hazardous Location GracePort® (M7)** is intended for environments where the user must do a "sniff test" and typically obtain a "Hot Work Permit" before opening the enclosure. Computer access ports and specific network solutions are available for Ethernet, DeviceNet, Data Highway Plus, Modbus Plus, Profibus, Fipway and others. The housing is especially well suited for use with the GracePort Low Profile Circuit Board for ease of field wiring.

Housings only meet both domestic and international code requirements.

Class I, Div. 1 & 2, Groups A,B,C,D

Class I, Zones 1 & 2, Groups IIB +H2, IIA

Class II, Div. 1 & 2, Groups E,F,G

Class III

NEMA 3,4,7 (B,C,D), 9 (E,F,G)

CENELEC - EEx D IIB IP66

GracePort® Stainless Steel Housing (Non-UL)

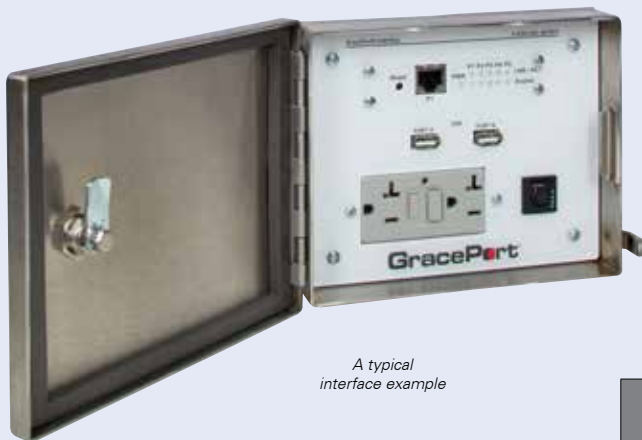
NEW

A typical
interface example

NEW GracePort® #304 Stainless Steel JB7 Housing

protects all the components, circuit breakers and power options featured on our fully customizable GracePort®. The durable design mounts securely to the outside of an enclosure and provides protection for valuable components from dust, dirt, oil, water, and other environmental contaminants found in highly corrosive industrial settings.

The **JB7 Stainless Steel Housing** features a low profile ideal for tight spots, tool entry with a quarter-turn latch and padlock ability for restricted access.

HOUSING CODE	HEIGHT (inches [mm])	WIDTH (inches [mm])	DEPTH (inches [mm])
JB7	5.63 [142.9]	7.10 [180.4]	1.38 [34.9]

GracePort® Stainless Steel UL Type 4X Housing

Keep stainless steel enclosures closed with the **#304** or **#316** stainless steel GracePort® interface. Grace offers thousands of combinations of cables, connectors and outlets, all available to ship in days!

The **M5 & M6 Stainless Steel Housings** are UL Recognized and are the perfect solution for enclosures with limited space. The extended profile on the **M5 & M6 Housings** accommodate for any additional component wiring within the electrical enclosure. A padlockable door with a screw-down clamp provides tool access for qualified personnel.



HOUSING CODE	HEIGHT (inches [mm])	WIDTH (inches [mm])	DEPTH (inches [mm])
M5	4.34 [110.2]	6.33 [160.8]	2.20 [55.8]
M6			

Surface Mount UL Type 4

MOUNTING AND OVERALL DIMENSIONS (inches [mm])								
Housing Code	Weight (oz)	A	B	C	D	E	F	G
A3	7.5	2.76[70]	1.57[40]	3.22[82]	2.05[52]	.22[5.5]	2.64[67]	1/2" NPT
G3	11.9	5.20[132]	1.77[45]	5.67[144]	2.24[57]	.22[5.5]	2.80[71]	3/4" NPT
L3	45.2	4.37[111]	4.17[106]	5.55[141]	4.72[120]	.25[6.4]	4.65[118]	1" NPT



Housing Code: A3



Housing Code: G3



Housing Code: L3

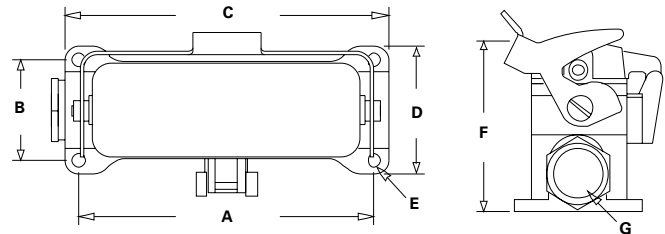

Inside-Outlet® GFCI Utility Receptacle

Grace Engineered Products' Inside-Outlet® is unique because it has three GFCI-protected receptacles – two outside and one inside the panel. Additionally, this GFCI receptacle's purpose is to provide companies a trouble-free step toward complying with NFPA 79, which states all externally-mounted utility receptacles must be GFCI protected and tested every 30 days. Accomplishing this directive is simple and time efficient with Inside-Outlet®. The non-GFCI outlets inside a panel can be wired through the Inside-Outlet®, which is then externally mounted on the panel door. Now testing is easy – just walk up to the door, flip the protective cover and push the button!



INSIDE-OUTLET® GFCI OUTLETS	PART NUMBER
UL Type 12/4	H-RF0-K3
with 15A CB	H-RF15-K3
with 20A CB	H-RF20-K3
with Class CC Fuse Holder*	H-RF030-M3-H
UL Type 4X	H-RF0-K2
with 15A CB	H-RF15-K2
with 20A CB	H-RF20-K2
with Class CC Fuse Holder*	H-RF030-M2-H
UL Type 1	H-RF0-K1
with 15A CB	H-RF15-K1
with 20A CB	H-RF20-K1
with Class CC Fuse Holder*	H-RF030-M1-H

*For higher interrupting rating, class CC Fuseholder (30A) included requires larger "M" sized housing. Fuse by customer.

GracePort®+ HMI Covers

GracePort®+ is a Human Machine Interface (HMI) cover kit that complements our existing line of GracePort® components and Permanent Electrical Safety Devices (PESDs) by conveniently placing them within a large protected housing. The strong and rigid design mounts securely to the outside of an enclosure and makes accessibility to electronic components easy. The standard **GracePort®+ HMI cover** is UL Recognized* with a Formed-In-Place (FIP) polyurethane gasket that protects valuable components from dust, dirt, oil, water, and other environmental contaminants found in the industrial setting. The clear cover is made with polycarbonate thermoplastic and is UV rated.

*Standard GracePort®+ HMI Covers are UL recognized. Final product certification will vary based on component selection.

NEW



OVERALL DIMENSIONS (inches [mm])							
Housing Size	A	B	C	D	E	F	G
10" x 8"*	8.47 [215.2]	6.69 [170.0]	10.50 [266.7]	10.08 [256.1]	2.40 [60.9]	9.05 [229.7]	18.09 [459.5]
12" x 10"	10.47[266.0]	8.69 [220.8]	12.50 [317.5]	12.08 [306.7]	2.40 [60.9]	11.04 [280.5]	22.09 [561.1]
14" x 12"	12.48 [317.1]	10.71 [272.1]	14.50 [357.7]	14.08 [357.7]	2.40 [60.9]	13.04 [331.3]	26.09 [662.7]
16" x 14"*	14.49 [368.0]	12.71 [322.8]	16.50 [419.1]	16.09 [408.6]	2.40 [60.9]	15.05 [382.1]	30.09 [764.3]

*NEW sizes coming in December 2016! Call our inside sales department for more information at 1.800.280.9517.

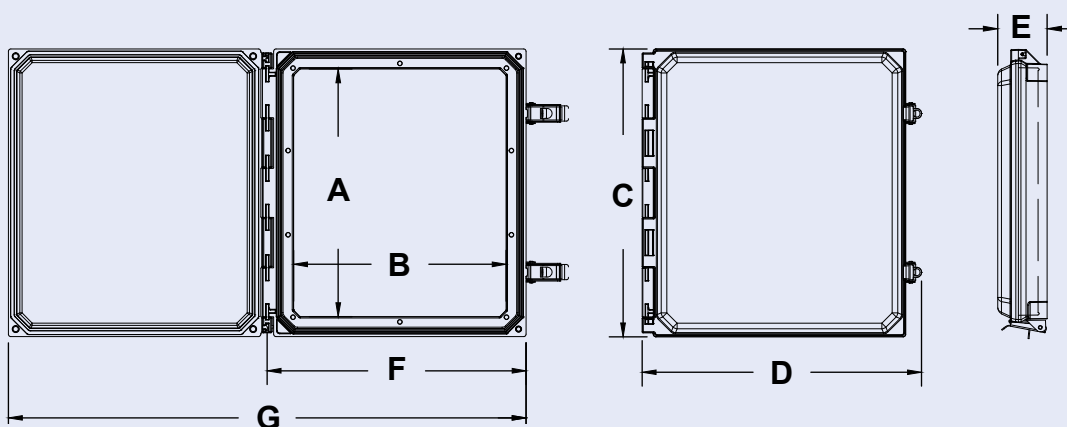

GracePort®+ Fully Assembled



GracePort®+ HMI Cover with optional UL Recognized Type 1 GracePort®





POWER / CIRCUIT BREAKER





We have various power options for international and domestic use available. Because circuit breakers offer the ability to limit what devices can be run through the GracePort®, we offer different amperages to fit your exact need.



CHS Controls AB
Tel +46 42 38 61 00, Fax +46 42 38 61 29
chs@chscontrols.se www.chscontrols.se





Domestic Power Options

DESCRIPTION	VAC	AMPS	POWER CODE
Null Power Option			RX
Simplex	120	15	 R
Duplex Outlet	125	20	 RD
GFCI Inside-Outlet Rear Outlet 15 AMP, (UL recognized for 15 AMPS)	125	20	 RF
Isolated Ground (Duplex)	125	15	RG
IEC 320 Male Power Entry Module	250	15	 RM
IEC 320 Female Power Entry Module	250	10	 RP
Two Duplex Outlets			RDD
Outlet (2) Square			RR
Outlet (3) Square			RRR

DESCRIPTION	VAC	AMPS	POWER CODE
Twist Lock Receptacle	125	15	 RN
Power AC Inlet with On/Off Switch, 2 Pole	250	10	 RS
DC Jack Female	12	5	 RL
220 Volt Power Outlet	250	15	 RY
USB Charger Receptacle: 2 Port, 3 amp, 5 VDC USB	125	15	 RDC

International Power Options

DESCRIPTION	VAC	AMPS	POWER CODE
Australia, New Zealand & People's Republic of China	250	10	 <p>RA</p>
United Kingdom, Hong Kong, Ireland, Singapore & Malaysia	250	13	 <p>RB</p>
United Kingdom with GFCI	250	16	 <p>RBF</p>

DESCRIPTION	VAC	AMPS	POWER CODE
Continental Europe "Schuko" <i>(Germany, Finland, Netherlands, Norway, Sweden, Portugal, Spain, Greece, Soviet Republic & Eastern Bloc)</i>	250	16	 <p>RE</p>
France & Belgium	250	16	 <p>RH</p>
India	250	15	 <p>RU</p>
	250	6/16	 <p>RIN</p>

DESCRIPTION	VAC	AMPS	POWER CODE
Thailand	250	15	 RW
Brazil	250	15	 RQB
Israel	250	16	 RZ
Argentina	250	10	 RAG
Continental Europe GFCI	230	16	 REF

DESCRIPTION	VAC	AMPS	POWER CODE
Italy	250	16	 RI
Switzerland	250	10	 RSW
Universal International	250	20	 RUV

Circuit Breaker Codes

No Breaker	0
1 AMP	1
2 AMP	2
3 AMP	3
5 AMP	5

6 AMP	6
8 AMP	8
10 AMP	10
15 AMP	15



CUSTOMIZE

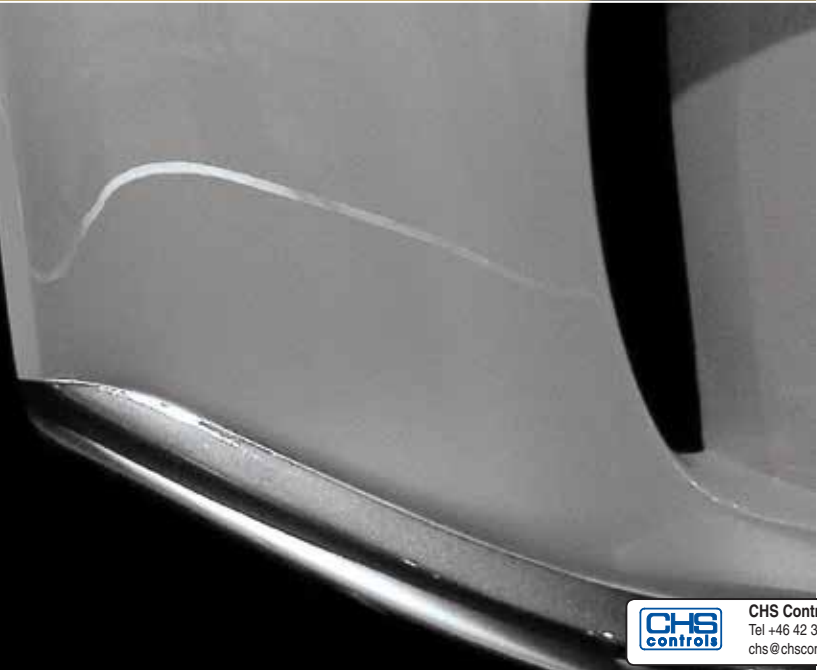

We customize. That's what sets a GracePort® apart from other communication ports. We can create a custom-built GracePort, including special text, cut-outs, cable lengths, and even adding your company logo, all in just a few days. Assembled in the USA and created just the way you want it.

Special Text



*We can print any logo, no limitations.
(JPG, BMP; minimum 600 dpi required)*

Non-Custom

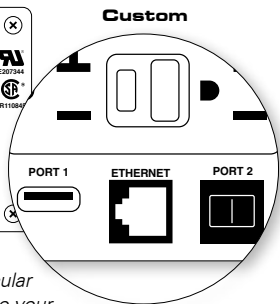
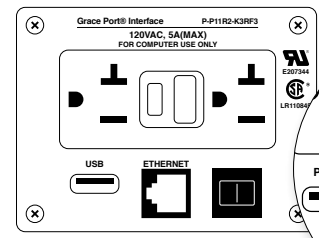

*If you ever need a certain connector labeled with a particular phrase or word that is unique to your industry or company, we can do that for you!
Call us at 800.280.9517 for more information!*

Cable Lengths



At Grace, our standard cable length for most components with cables is 10', however we often have longer or shorter cables available. To find out if the component you need has a different cable length, contact Inside Sales at 800.280.9517.

Custom Cutouts

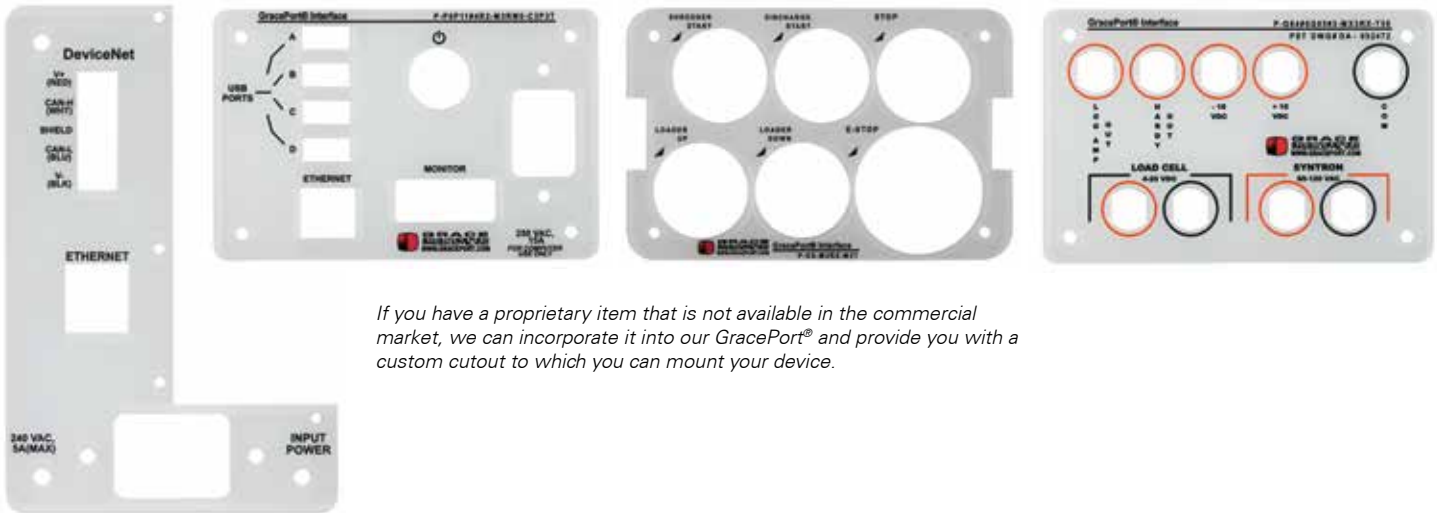

If you have a proprietary item that is not available in the commercial market, we can incorporate it into our GracePort® and provide you with a custom cutout to which you can mount your device.

Special Size UL Type 1



If you need a special control board, you can use our custom UL Type 1, which will allow us to create a GracePort® up to 24" x 10" without a housing for you to mount. Contact Inside Sales at 800.280.9517 for additional information.

NEW

See pg. 27 for details

GracePort®

DURABLE DESIGN WITH SAFETY IN MIND

WITH THE NEW LOW-PROFILE GRACEPORT®
JB7 STAINLESS STEEL HOUSING

INTRODUCING A NEW GRACEPORT®
STAINLESS STEEL JB7 HOUSING.

GracePort® Stainless Steel JB7 Housing is made of #304 stainless steel and protects all the components, circuit breakers and power options featured on our fully customizable GracePort®. By placing components within a Stainless Steel Housing, qualified personnel can ensure ultimate protection in highly corrosive environments.



CHS Controls AB
Tel +46 42 38 61 00, Fax +46 42 38 61 29
chs@chscontrols.se www.chscontrols.se

GracePort[®]



FAQs



CHS Controls AB
Tel +46 42 38 61 00, Fax +46 42 38 61 29
chs@chscontrols.se www.chscontrols.se

GRACEPORT® STAINLESS STEEL HOUSINGS

Where should I use Stainless Steel Housings?

Stainless Steel housings are applicable in industrial settings where corrosion may occur. The water resistant seal on the housings also make them great for wet or moist settings. Contact your representative to find a housing solution to match your environmental needs.

What are some typical applications?

Stainless steel housings are applicable in many industries including: water treatment, chemical, pharmaceutical, dairy, food and beverage, oil and gas. Contact your representative to find a housing solution to match your industry specific needs.

Are these housings waterproof or water resistant?

The stainless steel housing gasket provides a great seal from outside contaminants, however, they are not meant to be fully submerged in water.

What are the main differences between the NEW JB7 model and the M5 & M6 models?

The JB7 housing is non-UL, NEMA Type 4X and has a low profile. It also features a quarter-turn latch for tool entry. The M5 & M6 housings are UL recognized and have an expanded profile, accommodating more space for additional wiring.

Are all the stainless steel housings UL Recognized?

The M5 and M6 housings are UL recognized. Actual product certification will depend on component selection.

How do I ensure proper installation?

An installation guide is included in the product shipment. Special care should be taken to shield sensitive components from metal shavings and/or debris.

Do SafeSide Permanent Electrical Safety Devices (PESDs) work with these housings as well?

The Voltage Test Station will fit within the stainless steel housings and as always custom solutions are available to accommodate a variety of additional connectors and power options. Contact your local sales representative for more information and how to customize your GracePort®.

Can I get my company logo printed on the faceplate?

Absolutely. Custom logo and text options are available on all of our faceplates. The recommended file resolution is 600dpi .jpg for submitted text and logos. Contact your local sales representative for more details.

GRACEPORT®+ LARGE HOUSINGS (HMI COVER)

What brands of HMIs are compatible?

The GracePort®+ is designed to accommodate a wide variety of HMIs from several leading manufacturers. The maximum viewing area permitted is 8.69" (221mm) x 10.47" (266mm) for the 12" model and 10.71" (272mm) x 12.49" (317mm) for the 14" model.

Where should I use this?

It is highly recommended in harsh industrial environments such as process industries, manufacturing, and outdoor applications. The HMI cover protects your high value HMIs and other electronic components from dust, dirt, oil, water, UV rays, and other environmental contaminants found in the industrial setting.

Can I order an HMI with my GracePort+?

While the GracePort®+ is built to accommodate HMIs, they are sold separately from their respective manufacturers and distributors.

What is the IP Rating?

All HMI covers kits meet the IP66 rating as defined by IEC 60529.

How do I ensure proper installation?

An installation guide is included in the product shipment that contains a to-scale mounting template. Special care should be taken to shield sensitive components from metal shavings and/or debris.

What tools will I need for proper installation?

You will need a cutting tool appropriate for material being removed, centering punch, hammer, 7/32 to 1/4 drill bit, drill, file or equivalent deburring tool, 3/8 Wrench or socket and appropriate driver, #2 Philips screwdriver and an inch pound torquing device.

Are all these cover kits UL Recognized?

The standalone HMI cover kit is UL recognized. Use UL Type 1 GracePort® along with the HMI Cover Kit to maintain your cabinets environmental rating.

Are the housings lockable?

Yes, the housing is constructed with a latch that supports a standard padlock. Padlock not included.

Can this be installed in outdoor environments?

Yes, equipment can be mounted within the HMI covers in outdoor applications environmental ratings of UL Type 4X. The housings are also UV rated to protect from the damaging effect of UV light.

Can I get my company logo printed on the faceplate?

Absolutely. Custom logo and text options are available on the GracePort®+ faceplate. The recommended file resolution is 600dpi .jpg for submitted text and logos. Contact your local sales representative for more details.

NEW

See pg. 45 for details

SAFESIDE 

EASY INSTALLATION SAFER VERIFICATION

▶ **WITH THE NEW FLEX-MOUNT
VOLTAGE INDICATOR**

SafeSide® Flex-Mount voltage indicators provide visual energy verification while keeping workers away from voltage. The voltage indicator is ideal to mount on any electrical equipment or housing with M20 or 3/4" conduit knockout. Directional mounting with factory supplied labels allows installation flexibility for optimal LED visibility while mounted on the left, right, top or bottom of the equipment.



UL **US**
LISTED

CE



CHS Controls AB
Tel +46 42 38 61 00, Fax +46 42 38 61 29
chs@chscontrols.se www.chscontrols.se

SAFESIDE®



CATALOG



CHS Controls AB
Tel +46 42 38 61 00, Fax +46 42 38 61 29
chs@chscontrols.se www.chscontrols.se

Permanent Electrical Safety Devices (PESDs) are electrical components hardwired to a source of voltage(s) and installed into electrical systems enabling workers to validate zero electrical energy without being exposed to voltage. PESDs inherently minimize arc flash and shock hazards because they reduce voltage exposure, provide voltage labeling on all sources and provide 24/7 visual and/or audible indication of voltage.

Welcome to SafeSide®

About SafeSide® PESDs	43
Voltage Indicators	45
Voltage Portals	47
Combo Units	51
Accessories/Kits	55
SafeSide® FAQs	58

800.280.9517

42

www.pesd.com



CHS Controls AB
Tel +46 42 38 61 00, Fax +46 42 38 61 29
chs@chscontrols.se www.chscontrols.se

About SafeSide® PESDs

NEW Flex-Mount voltage indicators provide visual energy verification while keeping workers away from voltage. The voltage indicator is ideal to mount on any electrical equipment or housing with a M20 or 3/4" conduit knockout. Directional mounting with factory supplied labels allows installation flexibility for optimal LED visibility while mounted on the left, right, top or bottom of the equipment.

Voltage Indicators: Typically hardwired to the load side of the disconnect the SafeSide® voltage indicators, which are PESDs, illuminate whenever hazardous voltage is present in any individual phase.



R-3W

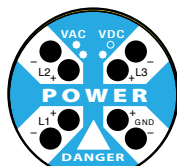

R-3W2

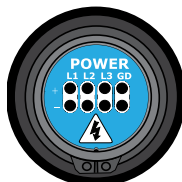

R-3F2



R-1V



R-3D2

Voltage Portals: The SafeSide® voltage portals are PESDs that reduce arc flash risks and increase electrical safety by providing maintenance personnel a no-touch voltage portal on the outside of grounded metal electrical enclosures.



R-1A



R-T3



R-3K

Safe-Test Point™: A High impedance protected PESD that allows workers to safely verify the presence or absence of voltage from outside the electrical cabinet through a metered test without the risk of being exposed to arc-flash and greatly reduces the severity of shock.



R-3MT-KIT-H

Voltage Test Station: combines our Safe-Test Point™ with a voltage indicator conveniently placed within a protective housing. The VTS test point jacks allow measurement of AC/DC voltages either phase to phase or phase to ground.









P-S10S21-M2RX-V

VOLTAGE INDICATORS

After disconnecting power to an enclosure, electricians can pre-verify voltage isolation while the enclosure door is safely closed. The risk of arc flash is reduced because electricians know if there is power inside the enclosure before re-verifying isolation.



CHS Controls AB
Tel +46 42 38 61 00, Fax +46 42 38 61 29
chs@chscontrols.se www.chscontrols.se

DESCRIPTION	LABEL DIMENSIONS	CUT-OUT DIMENSIONS	PART NUMBER	
Voltage indicator, multi-environment, flashing LEDs, 20-600VAC 50/60Hz, 20-1000VDC	1.25"W x 1.5"H	M20 or 3/4" conduit knockout	R-3D2	 NEW
Voltage indicator, multi-environment, non-flashing LEDs, 20-600VAC 50/60Hz, 20-1000VDC			R-3D2-SR	
Voltage indicator, multi-environment, flashing LEDs 20-600VAC 50/60Hz, 20-1000VDC			R-3D2-W5	
Voltage indicator, multi-environment, non-flashing LEDs, 20-600VAC 50/60Hz, 20-1000VDC			R-3D2-SRW5	
Voltage indicator, multi-environment 40-600VAC 50/60Hz, 30-1000VDC	3"W x 2.3"H	30mm pushbutton hole	R-3W2	
Voltage indicator, flashing LEDs 40-600VAC 50/60Hz, 30-1000VDC	3"W x 2.3"H	30mm pushbutton hole	R-3W	
Voltage indicator, non-flashing LEDs 40-600VAC 50/60Hz, 30-1000VDC	3"W x 2.3"H	30mm pushbutton hole	R-3W-SR	
Voltage indicator, flashing LEDs, label 40-600VAC 50/60Hz, 30-1000VDC	3"W x 2.3"H	30mm pushbutton hole	R-3W-L-KIT	
Voltage indicator, non-flashing LEDs, label 40-600VAC 50/60Hz, 30-1000VDC	3"W x 2.3"H	30mm pushbutton hole	R-3W-SR-KIT	
Voltage indicator, optical light cable assembly [Light cable lengths of 12", 24", 36", 48", and 72"] 20-600VAC 50/60Hz, 20-1000VDC	2.7"W x 2.2"H [Label sold separately]	30mm pushbutton hole	R-3F2-L12, R-3F2-L24, R-3F2-L36, R-3F2-L48, R-3F2-L72	
Voltage indicator, flashing LEDs, vertical label	1.6"W x 2.6"H	30mm pushbutton hole	R-3W-F-KIT	Not Shown
Voltage indicator, Qty (3) single-phase medium [monitors voltage 2000KV to 15000KV]	N/A	1/2" bolt hole	R-1VL003	
Voltage indicator, Qty (3) single-phase medium [monitors voltage 15000KV to 43000KV]	N/A	1/2" bolt hole	R-1VH003	









VOLTAGE PORTALS

SafeSide® voltage portals installed on an electrical panel, allow maintenance people to use a non-contact voltage detector pen to check line voltage before and after they open the main disconnect.



CHS Controls AB
Tel +46 42 38 61 00, Fax +46 42 38 61 29
chs@chscontrols.se www.chscontrols.se

DESCRIPTION	LABEL DIMENSIONS	CUT-OUT DIMENSIONS	PART NUMBER	
Voltage portals, Qty (3) single-point, single-phase, horizontal label	6"W x 3"H	1/2 inch hole	R-1A003-LPH	
Voltage portals, Qty (3) single-point, single-phase, vertical label	1.9"W x 11"H	1/2 inch hole	R-1A003-LPF	
Voltage portal, Qty (1) single-point, single-phase, label	3"W x 3"H	1/2 inch hole	R-1A-LPA	
Voltage portal, Qty (1) three-point, three-phase	Ø1.64	30mm pushbutton hole	R-T3	
Voltage portal, Qty (1) two-point, three-phase	N/A	30mm pushbutton hole	R-3K	
Safe-Test Point™	4"W x 4.60"H	30mm pushbutton hole	R-3MT-KIT-H	

NEW

See pg. 51 & 52 for details

SAFESIDE®

ELECTRICAL SAFETY MADE SAFER

▶ WITH THE NEW SAFE-TEST POINT™

The Safe-Test Point™ is a Permanent Electrical Safety Device (PESD) that allows qualified personnel to safely verify presence or absence of voltage. This high impedance protected device provides the capability to measure voltage from outside the enclosure, minimizing risk of arc flash and shock hazard. Through a closed-door metered test, workers can quickly and accurately perform routine tasks while feeling safer.



UL
LISTED

CE
RoHS



CHS Controls AB
Tel +46 42 38 61 00, Fax +46 42 38 61 29
chs@chscontrols.se www.chscontrols.se

Burnie & Les



"Don't start yet, Les, I almost got it." "And done."

SUIT DOWN

PESDs: The PPE You Don't Wear

Instead of suiting up in PPE, suit down while increasing safety and productivity by doing lock-out/tag-out through the panel door with Permanent Electrical Safety Devices (PESDs) by Grace Engineered Products.

- Quickly and safely perform Lockout/Tagout (LOTO)
- Confidently verify zero electrical energy
- Enhance your electrical safety program through safety-by-design. Increase compliance to NFPA 70E / CSA Z462 with PESDs!

For more information visit www.pesd.com.

VOLTAGE TEST STATION

Enhance your electrical
safety program through
safety-by-design.



CHS Controls AB
Tel +46 42 38 61 00, Fax +46 42 38 61 29
chs@chscontrols.se www.chscontrols.se

















COMBO UNITS







Combining the 24/7 outside the cabinet visibility of the voltage indicator with the physical and redundant action of checking a voltage portal, our Combo Units incorporated in LOTO exceed the high safety standard of NFPA 70E / CSA Z462.



CHS Controls AB
Tel +46 42 38 61 00, Fax +46 42 38 61 29
chs@chscontrols.se www.chscontrols.se

DESCRIPTION	LABEL DIMENSIONS	CUT-OUT DIMENSIONS	PART NUMBER	
Voltage indicator, flashing red LEDs, Qty (1) Safe-Test Point™, Qty (1), Vertical mount	N/A	Refer to page 22 & 23 for cut-out details	P-S10S21-M2RX-V	
Voltage indicator, flashing red LEDs, Qty (1) Safe-Test Point™, Qty (1), Horizontal mount	N/A		P-S10S21-M2RX	
Voltage indicator, flashing red LEDs, Qty (1) Safe-Test Point™, Qty (1), Horizontal mount	N/A	Refer to page 22 & 23 for cut-out details	P-S11S21-M3RX	
Voltage indicator, flashing red LEDs, Qty (1) Safe-Test Point™, Qty (1), Vertical mount	N/A		P-S11S21-M3RX-V	
Voltage indicator, non-flashing red LEDs, Qty (1) Safe-Test Point™, Qty (1), Vertical mount	N/A	Refer to page 22 & 23 for cut-out details	P-S12S21-M2RX-V	
Voltage indicator, non-flashing red LEDs, Qty (1) Safe-Test Point™, Qty (1), Horizontal mount	N/A		P-S12S21-M2RX	
Voltage indicator, flashing red with amber ground LEDs, Qty (1), Safe-Test Point™, Qty (1) Horizontal mount	N/A	Refer to page 22 & 23 for cut-out details	P-S13S21-M3RX	
Voltage indicator, flashing red with amber ground LEDs, Qty (1), Safe-Test Point™, Qty (1) Vertical mount	N/A		P-S13S21-M3RX-V	
Voltage indicator, flashing red LEDs, Qty (1) Safe-Test Point™, Qty (1), Horizontal combo label	4.30" H x 6.50" W	(2) 30mm pushbutton holes	R-3WMT-LMH	
Voltage indicator, flashing red LEDs, Qty (1) Safe-Test Point™, Qty (1), Flange combo label	10.00" H x 1.90" W	(2) 30mm pushbutton holes	R-3WMT-LMF	
Voltage indicator, flashing red LEDs, Qty (1) Safe-Test Point™, Qty (1), Flange combo label	10.00" H x 1.90" W	(2) 30mm pushbutton holes	R-3W2MT-LMF	
Voltage indicator, flashing red LEDs, Qty (1) Safe-Test Point™, Qty (1), Horizontal Combo label	4.30" H x 6.50" W	(2) 30mm pushbutton holes	R-3W2MT-LMH	

DESCRIPTION	LABEL DIMENSIONS	CUT-OUT DIMENSIONS	PART NUMBER	
Voltage indicator, non-flashing red LEDs, Qty (1) Safe-Test Point™, Qty (1), Horizontal combo label	4.30"H x 6.50"W	(2) 30mm pushbutton holes	R-3WSMT-LMH	
Voltage indicator, non-flashing red LEDs, Qty (1) Safe-Test Point™, Qty (1), Flange combo label	10.00"H x 1.90"W	(2) 30mm pushbutton holes	R-3WSMT-LMF	
Voltage indicator, flashing red with amber ground LEDs, Qty (1), Safe-Test Point™, Qty (1) Flange combo label	10.00"H x 1.90"W	(2) 30mm pushbutton holes	R-3WAMT-LMF	
Voltage indicator, flashing red with amber ground LEDs, Qty (1), Safe-Test Point™, Qty (1) Horizontal combo label	4.30"H x 6.50"W	(2) 30mm pushbutton holes	R-3WAMT-LMH	
Voltage indicator, multi-environment, Qty (1) Voltage portal, single-point, single-phase, Qty (3) Horizontal combo label	4"H x 9"W	(1) 30mm pushbutton hole, (3) 1/2 inch holes	R-1A0033W2-NPLPH	
Voltage indicator, flashing LEDs, Qty (1) Voltage portals, single-point, single-phase, Qty (3) Horizontal combo label	4"H x 9"W	(1) 30mm pushbutton hole, (3) 1/2 inch holes	R-1A0033W-NPLPH	
Voltage indicator with non-flashing LEDs, Qty (1) Voltage portals, single-point, single-phase, Qty (3) Horizontal combo label	4"H x 9"W	(1) 30mm pushbutton hole, (3) 1/2 inch holes	R-1A0033WSR-NPLPH	
Voltage indicator, flashing LEDs, Qty (1) Voltage portal, single-point, single-phase, Qty (1) Horizontal combo label	3"H x 6"W	(1) 1/2 inch hole, (1) 30mm pushbutton hole	R-1A3W-LPB	
Voltage indicator, multi-environment, Qty (1) Voltage portal, single-point, three-phase, Qty (1) Horizontal combo label	5"H x 6.5"W	(2) 30mm pushbutton holes	R-T3W2-LCH	
Voltage indicator, flashing LEDs, Qty (1) Voltage portal, single-point, three-phase, Qty (1) Horizontal combo label	5"H x 6.5"W	(2) 30mm pushbutton holes	R-T3W-LCH	
Voltage indicator, non-flashing LEDs, Qty (1) Voltage portal, single-point, three-phase, Qty (1) Horizontal combo label	5"H x 6.5"W	(2) 30mm pushbutton holes	R-T3WS-LCH	

DESCRIPTION	LABEL DIMENSIONS	CUT-OUT DIMENSIONS	PART NUMBER	
Voltage indicator, multi-environment, Qty (1) Voltage portal, single-point, single-phase, Qty (3) Flange combo label	14"H x 1.9"W	(1) 30mm pushbutton hole, (3) 1/2 inch holes	R-1A0033W2-NPLPF	
Voltage indicator, flashing LEDs, Qty (1) Voltage portals, single-point, single-phase, Qty (3) Flange combo label	14"H x 1.9"W	(1) 30mm pushbutton hole, (3) 1/2 inch holes	R-1A0033W-NPLPF	
Voltage indicator with non-flashing LEDs, Qty (1) Voltage portals, single-point, single-phase, Qty (3) Flange combo label	14"H x 1.9"W	(1) 30mm pushbutton hole, (3) 1/2 inch holes	R-1A0033WSR-NPLPF	
Voltage indicator, flashing LEDs, Qty (1) Voltage portal, single-point, single-phase, Qty (1) Flange combo label	9.5"H x 1.9"W	(1) 30mm pushbutton hole, (1) 1/2 inch hole	R-1A3W-LPBF	
Voltage indicator, multi-environment, Qty (1) Voltage portal, single-point, three-phase, Qty (1) Flange combo label	12.2"H x 1.9"W	(2) 30mm pushbutton holes	R-T3W2-LCF	
Voltage indicator, flashing LEDs, Qty (1) Voltage portal, single-point, three-phase, Qty (1) Flange combo label	12.2"H x 1.9"W	(2) 30mm pushbutton holes	R-T3W-LCF	
Voltage indicator, non-flashing LEDs, Qty (1) Voltage portal, single-point, three-phase, Qty (1) Flange combo label	12.2"H x 1.9"W	(2) 30mm pushbutton holes	R-T3WS-LCF	

A close-up photograph of a silver car's front end, showing the headlight assembly and a multi-spoke alloy wheel. A dark red horizontal band is overlaid across the middle of the image.

ACCESSORIES / KITS

Mount your SafeSide® PESDs exactly how and where you want with our accessories including door-mount kits and labels.



CHS Controls AB
Tel +46 42 38 61 00, Fax +46 42 38 61 29
chs@chscontrols.se www.chscontrols.se

Bezel Kit



Voltage indicator with Bezel kit – front

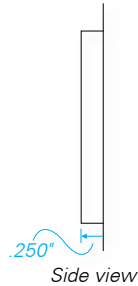

Side view



Voltage indicator with Bezel kit – back

Voltage indicator with flashing LEDs, with Bezel, 43.2mm hole **R-3W-KB**

Voltage indicator with non-flashing LEDs, with Bezel, 43.2mm hole **R-3W-SR-KB**

Multi-environment voltage indicator with Bezel, 43.2mm hole **R-3W2-KB**

Bezel and voltage indicator cannot be purchased separately.



Voltage indicator with label for Bezel kit

Label for Bezel, 3"W x 2.4"H **R-3W-KB-L**

Qty (1) horizontal label (goes with the R-T3), 4"W x 5.5"H **R-T3-LH**

Qty (1) vertical label (goes with the R-T3), 1.9"W x 8.8"H (not shown) **R-T3-LF**



Standard label for voltage indicators



Door mount kit
Applies to R-3W, R-3W2, R-3W-SR

Door mount kit with:
3' cable **R-3W-DR-C3**
4' cable **R-3W-DR-C4**
6' cable **R-3W-DR-C6**

Voltage indicator sold separately.



1 1/2 conduit vertical with R-3W

1 1/2 conduit vertical with VI nameplate **R-3W-NPT150-NP** (not shown)

DIN mount for R-3W, R-3W2, R-3W-SR **R-3W-DIN**

Voltage indicator sold separately.

NEW

See pg. 51 for details

SAFESIDE

SAFETY BY DESIGN

▶ WITH THE **VOLTAGE TEST STATION**

The **Voltage Test Station (VTS)** combines our Safe-Test Point™ with a voltage indicator conveniently placed within a protective housing. The VTS test point jacks allow measurement of AC/DC voltages either phase to phase or phase to ground. The R-3W Series voltage indicators with either flashing or non-flashing LEDs provide visual verification of voltage.



C **UL**® US RoHS **CE**



CHS Controls AB
Tel +46 42 38 61 00, Fax +46 42 38 61 29
chs@chscontrols.se www.chscontrols.se



FAQs



CHS Controls AB
Tel +46 42 38 61 00, Fax +46 42 38 61 29
chs@chscontrols.se www.chscontrols.se

SAFESIDE® VOLTAGE INDICATOR

(part numbers R-3W, R-3W-SR, R-3W2 and R-3F) Most FAQs below assume a typical 3 phase system

Why do I need to connect the green wire to earth ground?

A SafeSide® voltage indicator illuminates whenever there is a voltage differential existing between any two of the four leads. The green GND lead must be connected to a safe ground potential. Because a SafeSide® voltage indicator is a high impedance device, this ground connection can be made to virtually any type of ground (earth ground, signal ground, power ground). The NFPA 70E defines a hazardous voltage as 50 volts or more (referenced to earth ground). Without a solid connection to ground, the voltage indicator will not illuminate on a single phase condition which sets up false-negative voltage reading (voltage exists but is not displayed on the test instrument) and is a very dangerous situation.

What is most important for installation?

Verify and test that the ground connection is solid. Since the GROUND LEDs most likely do not illuminate in a typical balanced 480VAC 3Ø system, it is important to force the GND LED circuit to illuminate by disconnecting one of the phase leads (or pull a fuse).

Will the leakage voltage to ground on a SafeSide® voltage indicator adversely affect my power system?

No. With a typical balanced 480VAC 3Ø system, there is negligible current to ground because the GND LEDs typically do not illuminate. A maximum current of 455µA to ground exists when operating at the 1000 VDC level. If the GND LEDs illuminate during normal operation, there would be anywhere from 100-300 µA leakage current flowing to ground. It takes 60µA to operate the voltage indicator flashing circuit. A leakage current this small would have negligible effect on your power system even with a large number of SafeSide® voltage indicators installed.

Why do the GND LED indicators not illuminate?

This is normal with certain grounding schemes. The GND LEDs typically do not illuminate provided that the 3Ø line voltage on L1, L2 and L3 are balanced and there is no voltage or electrical noise on the GND leg. The GND LEDs will illuminate if an unbalance occurs from a blown fuse, ground fault or single phase condition. Note that it only takes 60µA to illuminate the LEDs in the GND leg.

What about HRG Systems? Isolated Ground Systems?

SafeSide® voltage indicators work on high resistance ground systems. In isolated ground systems, there needs to be a current path through ground to the rest of the circuit or the GND LEDs will not illuminate on a single phase condition. Sometimes isolated ground systems have enough capacitive connection to ground to allow a voltage indicator to function. To be sure a SafeSide® voltage indicator works on your isolated ground system, after wiring the voltage indicator to your 3Ø system, create a single phase condition by pulling two fuses to ensure that a ground connection exists.

Are SafeSide® voltage indicators phase sensitive? What if the green lead was accidentally wired to L1, L2, or L3?

No. SafeSide® voltage indicators are phase insensitive. The circuitry behind each of the four leads is identical. If the leads are incorrectly wired, the front phase indication would be incorrect, but the core functionality of the voltage indicator would stay the same. SafeSide® voltage indicators use a high impedance voltage detection circuit per phase to sense and illuminate AC or DC voltage. The illumination of the LEDs occurs only when current passes through two of these voltage detection circuits. Envision four identical voltage detection circuits (L1, L2, L3, GND) meeting each other in the center of the voltage indicator.

SAFESIDE® VOLTAGE INDICATOR

(part numbers R-3W, R-3W-SR, R-3W2 and R-3F) Most FAQs below assume a typical 3 phase system

Why does the SafeSide® voltage indicator illuminate when the power is off?

The LEDs on the SafeSide® voltage indicator may sometimes illuminate when no voltage is present on its lead wires simply due to induced voltage from other energized conductors. The LED flashing circuit is so sensitive that it only takes 60µA to activate the LED illumination circuit. For example, disconnects fed from a cable tray with other energized conductors may induce enough voltage to illuminate a voltage indicator wired to the line side of that disconnect. Leakage current from power semiconductors is also enough to cause LEDs to illuminate. Please consult factory for additional details.

What if one LED fails?

Redundant circuitry provides a second independently operated LED of opposite polarity for each phase, thereby leaving one LED to indicate voltage on that given phase. For DC systems, connecting the (2) leads to the DC+, (1) to DC common, and (1) to ground provides redundancy.

Do SafeSide® voltage indicators need a test function?

A SafeSide® voltage indicator, like any voltage detector, needs to be tested to determine if the “voltage detector is operating satisfactory”(NFPA 70E 120.1(5)). A SafeSide® voltage indicator is hardwired and can't be moved or tested to an independent voltage source. By installing SafeSide® voltage indicators on all sources, the OSHA required test-before-touch of each circuit part become much safer. A secondary SafeSide® Permanent Electrical Safety Device (PESD) (like our R-T3 voltage portal) is a suitable method of testing the operation of a SafeSide® voltage indicator. SafeSide® voltage indicators operate in a normally hazardous state (electrical systems are energized), are powered from the very hazard they indicate (no separate power supply to fail), and their TEST function is seeing it illuminate properly when the isolator is closed.

Do I need fuses?

SafeSide® voltage indicators are unique devices that are not specifically addressed in most of the codes and standard (NEC, NFPA 79, UL 508A). In addition, users typically install SafeSide® voltage indicators as a means of providing safety and not for providing a specific electrical control function. If the primary purpose of installing SafeSide® voltage indicators is for electrical safety, then it should not be fused because that adds additional connections between the voltage indicator and the voltage source, which affects reliability. The NEC allows for unprotected wires when safety is a higher priority. For example, the NEC also allows for fire pump motors to have unprotected control power circuits because it is more important that the fire pump works when there is a fire than for proper protection of control wires. For a more detailed discussion, see Over Current Protection section.

What are the UL issues and file number for SafeSide® voltage indicators?

SafeSide® voltage indicators have a C-UL-US Listing (Canada & US). A UL Listing means that there are no “Conditions of Acceptability” (like with a UL Recognized (UR) component). When UL tested these devices they shorted the internal circuitry, and then re-applied voltage without any physical damage due to excessive heat. Therefore, UL concluded that it could be applied without conditions of acceptability and gave these devices a UL Listing (UL with a circle). SafeSide® voltage indicators (R-3W, R-3W-SR and R-3F) are listed in the US and Canada under the UL CCN: NKCR (Auxiliary Device) and was evaluated under the UL 508 specification with file number E256847. The SafeSide® voltage indicator known as part number R-3W2 is UL Listed US and Canada for use in Class 1 Division 2 Environments with file number E334957.

SAFESIDE® SAFE-TEST POINT™

What is the shock hazard when using this device?

This high impedance device limits the available current at the test points to 4.7mA at 480V and 5.7mA at 600V. According to OSHA document 3075 (2002) page 7, “any shock hazard under 6mA is considered a slight shock; uncomfortable, but not painful.”

What would a typical Lockout/Tagout (LOTO) procedure include with this device?

Follow NFPA 70E Article 120.1 Verification of an Electrically Safe Work Condition. The R-3MT allows voltage measurements from phase to phase and phase to ground to check for presence and absence of voltage safely from outside the enclosure.

Where do I install the Safe-Test Point™ on my equipment?

Safe-Test Point™ can be directly wired to either the load side or line side of the LOTO voltage source point. It can also be directly wired onto the bus below the fuses to measure a blown fuse or a tripped circuit breaker.

What are the recommended connection accessories for Safe-Test Point™?

Recommendations may vary based on application, however, we suggest the following connectors: T&B Sta-Kon Series, 3M Scotchlok, Wago 773 Series, or Wago 222 Series.

Do I need Personal Protective Equipment (PPE)?

Use the recommended PPE based on your facility's electrical safety program and adhere to the PPE guidelines in Table 130.7 (C)(16) of the NFPA 70E.

What are the added benefits of the voltage indicator?

The voltage indicator provides a redundant verification and visual representation of voltage absence and presence from outside the door. In addition, the voltage indicator provides the indication of a blown fuse and/or phase loss in the circuit.

How do I perform a “live-dead-live” test with this device?

Always follow the “live-dead-live” test procedure as per OSHA and NFPA 70E (2015), Article 110.4(A)(5), 120.1, and Annex G. Sample procedure- with a properly rated test instrument, verify the test instrument to a known source, then insert the test probes into the R-3MT test point assembly to verify the presence of voltage. Next, open the isolator and proceed to verify the absence of voltage on the R-3MT assembly by measuring L1-L2, L1-L3, L2-L3, L1-G, L2-G and L3-G. Once you have verified voltage absence, re-verify the test instrument to a known source.

Can I use this device without the dust cap?

We recommend installing the dust cap on the R-3MT for each installation. The dust cap provides tool access for qualified personnel and also helps keep dust and contaminants away from the individual test points.

Do I need to follow any other safety procedures?

Always follow the safety procedure established by your facility and/or employer; in addition, we suggest following a sample procedure outlined on the assembly instructions provided with the Safe-Test Point™.

SAFESIDE® VOLTAGE TEST STATION

What is the value of the VTS?

The VTS combines our Safe-Test Point™ with a voltage indicator and conveniently places them within a UL Type protective housing (4, 4X and 12). The protective housing provides tool access for qualified personnel and also helps keep dust and contaminants away from the individual test points.

Is the VTS UL listed?

The VTS is UL recognized which enables OEMs (UL 508 Shops) to easily add to their existing UL File.

What are the added benefits of the voltage indicator?

The voltage indicator provides a redundant verification and visual representation of voltage presence from outside the door. In addition, the voltage indicator provides the indication of a blown fuse or phase loss in the circuit.

What are the recommended connection accessories for the Voltage Test Station?

Recommendations may vary based on application, however, we suggest the following connectors: T&B Sta-Kon Series, 3M Scotchlok, Wago 773 Series, or Wago 222 Series.

Where do I install the Voltage Test Station on my equipment?

Voltage Test Station can be directly wired to either the load side or line side of the LOTO voltage source point. It can also be directly wired onto the bus below the fuses to measure a blown fuse or a tripped circuit breaker.

What is the shock hazard when using this device?

This high impedance device limits the available current at the test points to 4.7mA at 480V and 5.7mA at 600V. According to OSHA document 3075 (2002) page 7, "any shock hazard under 6mA is considered a slight shock; uncomfortable, but not painful."

Do I need Personal Protective Equipment (PPE)?

Use the recommended PPE based on your facility's electrical safety program and adhere to the PPE guidelines in Table 130.7 (C)(16) of the NFPA 70E (2015).

What would a typical Lockout/Tagout (LOTO) procedure include with this device?

Follow NFPA 70E Article 120.1 Verification of an Electrically Safe Work Condition. The Voltage Test Station allows voltage measurements from phase to phase and phase to ground to check for presence and absence of voltage safely from outside the enclosure.

How do I perform a "live-dead-live" test with this device?

Always follow the "live-dead-live" test procedure as per OSHA and NFPA 70E (2015), Article 110.4(A)(5), 120.1, and Annex G. Sample procedure- with a properly rated test instrument, verify the test instrument to a known source, then insert the test probes into the R-3MT test point assembly to verify the presence of voltage. Next, open the isolator and proceed to verify the absence of voltage on the R-3MT assembly by measuring L1-L2, L1-L3, L2-L3, L1-G, L2-G and L3-G. Once you have verified voltage absence, re-verify the test instrument to a known source.

Do I need to follow any other safety procedures?

Always follow the safety procedure established by your facility and/or employer; in addition, we suggest following a sample procedure outlined on the assembly instructions provided with the Voltage Test Station.

Can I get my company logo printed on the face plate?

Absolutely. Custom logo and text options are available on the Voltage Test Station face plate. The recommended file resolution is 600dpi for submitted text and logos. Contact your local Sales Representative for more details.

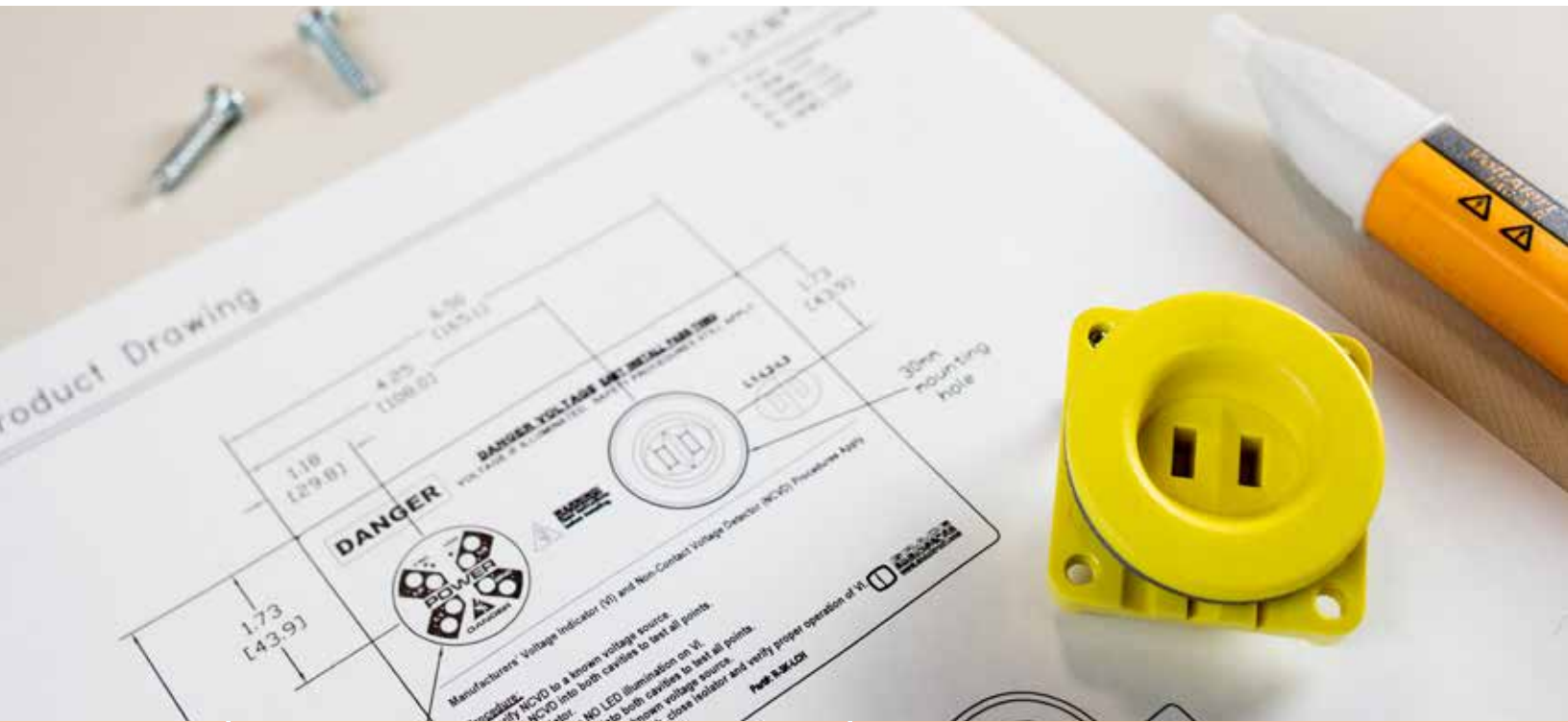

YOUR GUIDE TO PRODUCTIVE SAFETY



CHS Controls AB
Tel +46 42 38 61 00, Fax +46 42 38 61 29
chs@chscontrols.se www.chscontrols.se

Safety is the inspiration for all of the Grace Engineered Products. We are experts at designing products that manage electrical environments so the job can get done in the safest and quickest manner. We continually challenge our products and the work process to be better, safer and more controlled. The number of uniquely designed components grows daily... there are an infinite number of possibilities. By sharing these technical white papers we want to explain our products, our designs and our drive to keep getting better, to be safer.

Productively Safer Lock-Out Tag-Out Procedure with Permanent Electrical Safety Devices	65
Electrical Safety Refined by the Risk Control Hierarchy	71
Thru-Door Electrical Isolation Pre-Verification Application Note	77
Voltage Indicator Overcurrent Protection Application Note	79

PRODUCTIVELY SAFER LOCK-OUT TAG-OUT PROCEDURE WITH PERMANENT ELECTRICAL SAFETY DEVICES

Philip B Allen
Member, IEEE
Grace Engineered Products
5001 Tremont Avenue
Davenport, Iowa 52807 USA

Abstract – The NFPA 70E raised the standard for electrical workplace safety and fundamentally transformed methods regarding electrical and mechanical maintenance, and troubleshooting. These higher safety standards have inspired improvements to electrical system designs that increases both uptime and productivity, and reduces workers' exposure to arc flash and shock hazard risks. End-users continue to challenge electrical professionals to develop ways to better maintain energized or de-energized electrical equipment in accordance with NFPA 70E. As a result, many end-users have installed Permanent Electrical Safety Devices (PESDs), which allow for thru-door voltage verification without voltage exposure, on the outside of energized electrical equipment making them safer and simplifying mechanical and electrical lock-out/tag-out procedures (LOTO).

With Permanent Electrical Safety Devices (PESDs), workers can access the inside of the panel in a de-energized state without voltage exposure; a method which not only meets but exceeds the requirements of NFPA 70E 120.1(1-6)/CSA Z462 4.2.1. PESDs are, essentially, the PPE you don't wear, and provide necessary barriers between personnel and voltage. Because workers are on the outside of the panel, PESDs decreases the opportunity for arc flashes and shock incidents, which is the crux of NFPA 70E/CSA Z462.

Index Terms: Permanent Electrical Safety Devices, NFPA-70E, Voltage detection, Safety Device

I. Introduction

Permanent Electrical Safety Devices (PESD) are an electrical component(s) hardwired to a source of voltage(s) and installed into electrical systems enabling workers to validate zero electrical energy without being exposure to voltage. The PESD inherently minimizes arc flash and shock hazards because they reduce voltage exposure, provide voltage labeling on all sources and 24/7 visual and/or audible indication of voltage. Fig.1 shows an example of the Voltage Source Labels on a panel fed with 3-Phase 480VAC and 120V separate control. The PESD is mounted on the outside of the panel provides workers with the ability to determine all possible sources or electrical supply [1]. The use of a PESD can enhance safety procedures because workers have to perform a physical action(s) in addition to audible and visual voltage indications using a Non-Contact Voltage Detector. The Non-Contact Voltage Detector (NCVD) is a battery



Fig.1 Voltage Source Labeling

operated voltage detector pen that senses AC voltage without actually touching an energized conductor (50-1000VAC).

Either three phase or single phase source(s) can be extended to the outside of an electrical enclosure through an encapsulated non-conductive housing called a Voltage Portal. The Voltage Portal is designed for use with a NCVD to sense voltage. The NCVD will detect the presence of voltage when it is placed into the voltage portal. Fig 2 outlines the fundamental concept of a Voltage Portal and associated NCVD.

Alternatively a Light Emitting Diode (LED) type Voltage Indicator can be permanently hardwired to the phase(s) and ground. This device will illuminate when a voltage greater than 40VAC/30VDC is applied or when a differential exists between two lone inputs.

The typical requirements for 3-phase/4-wire Voltage Indicator include:

- Powered from the line voltage (no batteries)
- Wide operating AC/DC voltage range (40-750VAC/30-1000VDC)
- High surge immunity
- Meets 50 volt threshold as per NFPA 70E 110.6 (D)(1)(b), 110.7(E)5
- Cat IV and UL Certified to UL 61010-1 as per NFPA 70E 120.1(5) Informational Note.

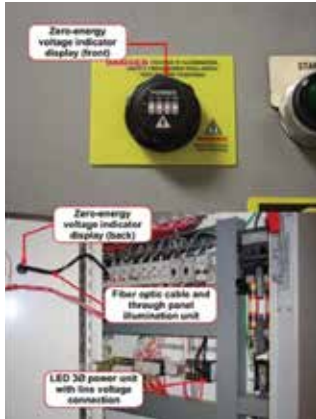

Fig. 3 Zero Energy Voltage Indicator System

Another useful indication system is a Zero Energy Fiber Optic Voltage Indicator. These types of indicators provide the same functionality as voltage indicators but they utilize non-conductive fiber optic cables that transmit visible light indication of the internal presence of voltage. With this system no voltage is brought to the outside of the enclosure or switchgear. Fig. 3 illustrates the use of a three phase voltage indicator mounted close as possible to the main disconnect with the leads routed away from high energy equipment that may affect the operation of the NCVD.

Improved safety builds upon time-tested safety principles. For years the precise language of NFPA 70E 120.1 has provided maintenance workers with a fundamental methodology for establishing zero electrical energy. Armed with portable voltmeters, workers have always depended on this single device as the primary means of proving the presence or absence of electrical energy in an electrical enclosure. Recently, workers discovered that PESDs, which are built into the electrical system and designed solely to indicate voltage, have significant advantages independent of the solo, portable voltmeter. The relatively new concept of PESDs improves the workers' ability to safely isolate and locate electrical energy beyond that which was originally conceived when Article 120.1 was written. With this said, workers should use PESDs as their primary instrument for detecting voltage and their voltmeter as their secondary instrument. With PESDs installed correctly into electrical enclosures, incorporated into safety procedures, and validated before and after each use, workers can transition the once-risky endeavor of verifying voltage into a less precarious undertaking that never exposes them to voltage. The visibility of PESDs on the enclosure exterior provides workers with the ability to "determine all possible sources of

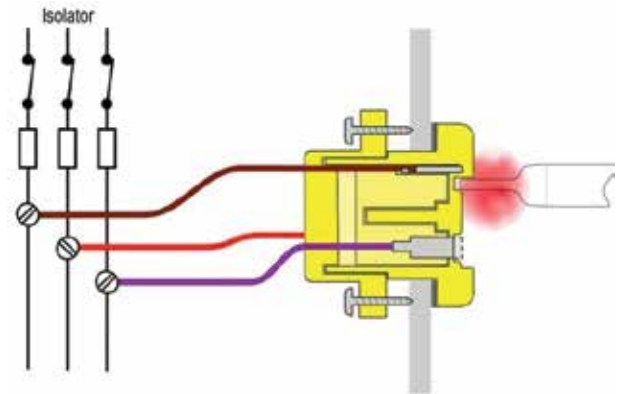

Fig. 2 Cutaway of three-phase voltage portal

electrical supply" (NFPA 70E 120.1(1)) feeding the enclosure. Electrical safety has been radically improved by eliminating exposure to voltage while using PESDs to validate zero electrical energy, which compliments the existing, proven practices without replacing them.

Using PESDs in an electrical safety program requires written lock-out/tag-out (LOTO) procedures. Employees need to be trained and have access to these procedures.[2]

II. Process of Validating and Testing Instruments

An electrically safe work condition requires 100% accuracy from voltage testing instruments. To ensure this, the NFPA 70E indicates that before and after each test, determine that the voltage detector is operating satisfactorily, (NFPA 70E 120.1(5)). Validation means that electricians first check their voltage testing instrument to a known voltage source (i.e. a nearby 120VAC outlet). Next, they check for zero voltage on the primary source. Work begins only after the voltage testing instrument is rechecked to the independent live voltage source. This straight-forward validation procedure works for a portable voltage detector because it can be physically moved between two voltage sources, but the same principle applies to PESDs. Over the past several years, PESDs have become a substantial way for companies to increase safety and productivity at the same time.

Fig. 4 illustrates the steps in the process of verifying voltage with a voltmeter. A voltage measuring instrument validates actual presence of voltage by displaying the voltage, while a Voltage Indicator alarms when voltage is within its range. A small current flow through the voltmeter is the way voltage is measured.



Fig. 4 Verifying the presence of voltage with a digital meter

One large forest products company in the Northwest region of the United States started using the voltage indicator PESDs in 2004 and quickly incorporated them into other facilities. The Manufacturing Services Manager for this company has indicated that the use of the fixed voltage indicators would allow us to avoid

opening starter or disconnect compartment doors for approximately 75% of all lockouts.[3] The same principles absolutely apply to other PESDs; however, because a PESD cannot be moved between two voltage sources, the technique for validation needs a slightly different approach.

So what actually needs to happen to validate any voltage testing instrument? Testing for voltage simply requires a small amount of current to flow between the two voltage potentials. The voltage detector circuit determines a voltage potential by relating this current flow to actual voltage and providing the worker an appropriate indication (audible, visual or digital display) (Fig. 4).

A. Validating a Voltage Portal & NCVD Combination



Fig. 5 NCVD to GRD functionality

A NCVD determines if voltage exists in a conductor by creating a low current capacitive circuit between the conductor, the NCVD, the worker, and ground (Fig. 5). Therefore, when the NCVD is positioned close to a live conductor, this completed circuit causes the NCVD to beep or flash telling the worker that voltage exists in the conductor.

For a NCVD to function, a high capacitance ground path is established through the worker. When the panel is energized, the worker tests and verifies both the NCVD and the ground path through the worker. The permanent location of the three phase voltage portal requires the

worker stand in the same location (or same ground path) every time the NCVD is used. Fig. 5 illustrates the ground path.[4]

Because voltage portals mount permanently to the outside of enclosures, the worker has to stand in the same place when using his NCVD. This makes this capacitive circuit more reliable and more repeatable than it would be when workers use a NCVD in all other application because the environment is always the same and doesn't change. Since NCVDs are portable, they can also be checked to an independent voltage source as per NFPA 70E 120.1(5).

Workers using NCVDs understand that since a NCVD isn't physically hardwired to the voltage source, their operation can be influenced by external conditions such as electrical noise and proximity to ground.

Those influences are greatly reduced by 1) where the voltage portal is mounted and 2) how the lead wires are routed within the enclosure. The fact that a voltage portal and the worker are always in the same location every time means reliability increases. Installing voltage portals as close as possible to the enclosure flange by the main disconnect and routing the lead wires away from other devices creates a more reliable installation.

Fig. 6 shows the proper locating of a three phase voltage portal close to the main disconnect and routing the lead wires away from any devices inside the enclosure that generate a lot of electrical noise increases the overall reliability of the NCVD voltage indication. Mounting PESDs on the enclosure flange makes the lead wires less susceptible to damage.



Fig. 6 Proper location of a three-phase portal

B. Validating a Voltage Indicator

A hardwired voltage indicator brings up two interesting issues. First, it is hardwired and you can't move it to an independent voltage source. Second, adding a switch to toggle between the line voltage and the test voltage adds more components and complexity, which leads to unreliability. This is impractical because it requires a 600V fused three-pole double throw relay. The fusing, the relay wiring, and switching introduces 18 connections (failure points) between the voltage source and the voltage indicator. Since the sole purpose of the voltage indicator is to indicate voltage, anything installed between the source voltage and the voltage indicator increases the chance of a false negative voltage reading - switches, relays and fuses included. (Note: A false negative is when voltage exists in a conductor and the voltage detector doesn't sense it).

Third, because of the 3-phase circuit design, a voltage indicator accommodates six current paths (FIG 7) between phase(s) and ground, thereby reducing the number of possible failure modes. In one possible circuit design, before a single LED illuminates, the current must pass through at least four LED flashing circuits. "Voltage when illuminated," as per the warning label, means if only one of the four LEDs illuminates; it still provides voltage indication to the worker. Validating this device requires it be checked for proper operation before and after each LOTO procedure and that the solid ground connection is checked upon installation so it will alarm on a single phase condition caused by a failed isolator.

III. Multi-Meters Compared to PESDs

The design of a typical voltage indicator is considerably different from a multi-meter because it has six possible current paths through four connected voltage detection circuits as per Fig. 7. When AC voltage is applied to this device, current must pass through two voltage detection circuits before the LED pairs illuminate. This means that current must pass through 4 LED's when indicating voltage. Each LED pair illuminates on the (+) and (-) side of the AC sine wave.

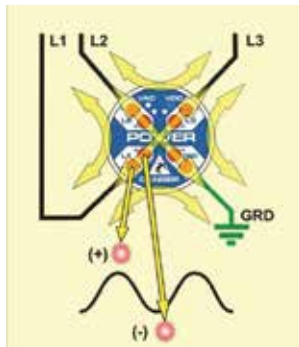

Fig. 7 Typical Voltage Indicator

Until PESD systems came along, creating electrically-safe work conditions relied solely upon the portable multi-meter. This tool is not only used in electrical safety, but has features making it invaluable for other purposes such as electrical troubleshooting and diagnostics. On the other hand, a PESD leaves no question or confusion when a worker uses it in creating an electrical safe work condition because it was designed, built, and installed for a single purpose—voltage indication for electrical safety. Understanding these differences helps determine an acceptable validation procedure for PESDs and show how they exceed the validation requirements of NFPA 70E 120.1

IV. Validating Voltage Indicators and Voltage Portals

Voltage indicators and voltage portals, as shown in Figs 8 and 9, are complementary because their strengths and weaknesses offset each other. Let's consider the primary voltage testing instrument to be the voltage indicator because it provides the hardwired connection to the voltage source as required by NFPA 70E 120.1(5). Then the

NCVD/voltage portal becomes the testing device for the voltage indicator. Both devices can be checked before a LOTO procedure to ensure proper operation while the control panel is energized (Chart 1). The traditional method of validating the voltage indicator to an independent voltage source is met with the NCVD/voltage portal combination. On the other hand, it can be argued that a voltage indicator by itself cannot be validated by the traditional method. However, because permanently-mounted voltage indicators are designed to only detect voltage, the built-in advantages over a simple multi-meter needs to also be considered in validating this device.

V. Written Loto Procedures and Mechanical LOTO

A PESD becomes a "real" safety device only after it is included as part of a written LOTO procedure. Without this, PESDs are nothing more than just another electrical component. The LOTO procedure must explain to the worker each step in the LOTO procedure that involves the PESD. At a minimum, workers will need to verify proper operation of the PESD before and after performing a LOTO procedure.



Fig. 8 Panel Mounted Indicators

As demonstrated in Fig. 8, when the control panel is energized, the worker verifies proper operation of the voltage indicator and the NCVD and its associated ground path through the worker.

Interestingly, the mechanical maintenance workers receive a huge benefit with PESDs when these devices are used in mechanical LOTO procedures. Workers performing mechanical LOTO (work involving no contact with conductors or circuit parts) procedures must still isolate electrical energy. PESDs provide a means of checking voltage inside an electrical panel without exposure to that same voltage. Without these devices, a mechanic performing mechanical LOTO would be required to work in tandem with an electrician using a voltmeter to physically verify zero voltage inside an electrical panel before work begins. In this case, the electrician is exposed to voltage. With PESDs, the mechanic can single-handedly check for zero electrical energy without any exposure to voltage, thereby making the LOTO procedure safer and more productive.

Continued on page 6/60

A Pennsylvania plant reduced their electrical maintenance staff down to one electrician during the day shift. To increase efficiency, the second and third shift operators began performing limited mechanical maintenance. By rewriting their LOTO procedure, installing voltage portals on each motor control center bucket, and training the operators to use non-contact voltage detectors with the voltage portals, the off-shift operators were able to perform the maintenance tasks that still complied with OSHA LOTO requirements [2].

VI. Reduced Arc Flash Risk and Personal Protective Equipment (PPE)

When workers can determine a zero electrical energy state without any voltage exposure to themselves; their electrical safety program is safer. Verifying the proper operation of a meter and testing for absence of voltage before working on an electrical conductors ("Test before Touch") for all practical purposes should always remain a habitual practice for workers. The goal of PESDs is to ensure that when workers 'test before touch', that they test only de-energized conductors.



Fig. 9 Verifying proper operation of the NCVD

Fig. 9 shows a NCVD being used to verify that proper operation of the voltage indicator. This is a secondary test for the absence of voltage.

Without PESDs, a failure of an isolator may go undetected until the electrician discovers live voltage after opening the panel. This exact scenario is a common cause of arc flash. A direct short circuit may result from one misstep by the electrician while checking voltage. Even worse yet, the electrician would take a direct hit in the face from the resulting arc flash. Because PESDs meet NFPA 70E 120.1 and the lessened risk of voltage exposure, some will conclude that once the panel is open the need for personal protection equipment (PPE) is also reduced. Whether or not you agree with this, voltage detectors are a low-cost, redundant voltage verification tool that reduces arc flash risk, increases safety, and adds productivity at a low installed cost.

VII. Conclusion

The precise language of NFPA 70E 120.1 has provided maintenance workers with a fundamental methodology for establishing zero electrical energy. Portable voltmeters have been what workers depend on as the primary means of proving the presence or absence of electrical energy in an electrical enclosure. However, the advantages of PESDs as the primary instrument for detecting voltage are abundant in that they improve the workers' ability to safely isolate and locate electrical energy beyond that which was originally conceived with Article 120.1.

VIII. References

- [1] NFPA 70E, 2012 *Standard for Electrical Safety in the Workplace* 120.1(1)
- [2] OSHA 29 CFR 1910.147 and 1910.333(b); NFPA 70E, 2012 *Standard for Electrical Safety in the Workplace* 120.2(B)(2), 120.2(C)(1)
- [3] W. S. Hopper, "One Mill's Response to a Specific Type of Arc Flash Problem," *IEEE Transactions on Industry Applications*, vol 45, pp 1184-1193, May/June 2009.
- [4] Duane Smith, "What Do You Know About Capacitive Voltage Sensors?" *Electrical Construction and Maintenance*, Aug. 1, 2005,
- [5] NFPA 70E 2012 *Standard for Electrical Safety in the Workplace* 110.6(D)(1)(b), 110.7(E).

IX. VITA

Phil Allen is the President and owner of Grace Engineered Products, the leading innovator of permanent electrical safety devices. He holds two US Patents, a power receptacle design and a voltage detector test circuit. His passion is finding new and more efficient ways of bringing electrical safety to the forefront. Phil did his undergraduate work at California State University, San Luis Obispo and is a 1984 graduate with a BSIE.

X. Appendix

	PESD Truth Table for Establishing Zero Electrical Energy (3-Phase System)					
	Primary – Voltage Indicator		Comments	Secondary – NCVD and 3Ø Voltage Portal		Comments
		Ground connection on GRD leg			Ground path	
All Three Phases Energized	For a 3Ø AC system the L1, L2, & L3 LED pairs all need to be illuminated. In some cases, the GRD LED illuminates	GRD leg must be verified upon installation		Alarms when inserted into the voltage portal	Ground path through worker is established and tested anytime a NCVD test succeeds when voltage is present on the voltage portal	See Fig. 8
One or Two Phase Energized (failed isolator or blown fuse(s))	One or two LED pairs and the GRD LED illuminated.	If no GRD connection, then LEDs will not illuminate on a single phasing condition.	If no ground connection exists, the voltage will not indicate on a single phase condition, therefore the NCVD-voltage portal would provide a redundant voltage test.	Alarms when inserted into the voltage portal (typically not phase sensitive)		
All Three Phases De-energized	No LEDs illuminated.			No indication or alarm from NCVD		NCVD verified to another voltage source after testing for zero voltage
Stored Energy (AC or DC)	Illumination of any single LEDs indicates voltage					See Fig. 6

Electrical Safety Refined by the Risk Control Hierarchy

Philip B Allen
 Grace Engineered Products
 5001 Tremont Avenue
 Davenport, Iowa 52807
 philallen@grace-eng.com

Abstract – The Risk Control Hierarchy (RCH) in the ANSI-Z10 standard provides electrical safety professionals with an excellent roadmap for setting the right safety objectives that result in the reduction of electrical risks. Combining our understanding of electricity with our principles of safety is the key to improving electrical safety. For example, when a Department of Energy electrical safety program is analyzed under the light of the RCH, many potential electrical safety improvements begin to jump off the page. The RCH not only helps improve a plant electrical safety program, but it also inspires manufacturers to improve their electrical equipment designs.¹ Lastly, the RCH provides a means to measure the effectiveness of an electrical safety initiative much the same way a project manager uses financial measurements (Return on Investment or Payback Analysis) to evaluate a project.

1. Introduction



Harold Pitney Brown

In the late 1880s, a young boy was electrocuted when he accidentally touched an unlabeled, energized telegraph wire. That incident ignited an inventor by the name of Harold Pitney Brown to make an impassioned plea in a New York Post editorial to limit telegraph transmissions to what he considered a safer level of 300 Volts.

Perhaps Harold thought that limiting electrical transmissions to levels of 300 Volts or less would provide instant electrical safety. With over 120 years of hindsight, we view things much differently today. Yet, Harold stumbled across two important concepts. The notion of “300 Volts” is a technical discussion about the laws of electrical energy (Ohm’s Law, etc) that lends understanding to how electrical energy can kill or maim. On the other hand, the term “safe” reflects a working knowledge of the fundamental principles of safety.

Our challenge is to combine our technical understanding of electricity with the principles of safety to ensure electrical safety is both practical and effective. The better we understand both concepts the greater the likelihood we will have to improve the status quo. The Risk Control Hierarchy (RCH) does an excellent job in blending these two key concepts.

2. Risk Control Hierarchy

The heartbeat of safety is the Risk Control Hierarchy (RCH), which is found in Appendix G of the ANSI Z10 Standard.² The RCH helps us prioritize safety initiatives from least effective to most



Figure 1

effective. For example, will you be safer wearing a helmet while riding a motorcycle or by selling it altogether? Obviously, selling the motorcycle eliminates the risk of an accident, while wearing a helmet offers protection to your head from the risk of a head injury during an accident. The RCH works by helping us rank risk reduction measures from most effective to least effective as per below:

1. **Eliminating** the risk.
2. **Substituting** a lesser risk.
3. **Engineering** around risk.
4. **Awareness** of every risk.
5. **Administrate** and regulate behavior around risk.
6. **Protect** workers while exposed to risk.

Note that each step above is equally important, yet *not equally effective in protecting workers*. Eliminating a risk is the most effective way to keep workers safe while protection from a risk by using Personal Protection Equipment (PPE) is least effective. There have been great improvements in the design of PPE, but its primary purpose is keeping workers alive – not 100% safe.

3. Safety and Risk

Risk, which is defined as exposure to a hazard, is two-pronged. There is the probability of exposure and severity of potential injury. For example, a 120V outlet is a greater risk than a 13.8KV switchgear line-up because more people are exposed to the 120V outlet. Since risk is exposure to hazards, then safety is the reduction and management of risk. The management responsibility of an electrical safety program typically falls to an electrical engineer because he or she understands electricity. In our modern world we can never eliminate the risk, but are very good at finding new ways to reduce risk.

Another way to look at risk is the chart (Figure 2) developed by Ray Jones which shows the relationship between the worker and the safety infrastructure above him.³ A worker performing tasks must make many complex and specific the decisions that affect his safety.

In the case of electrical safety, *energy isolation is very personal for electricians facing deadly electrical energy every time they open a panel.* By the time they touch electricity, it's too late.

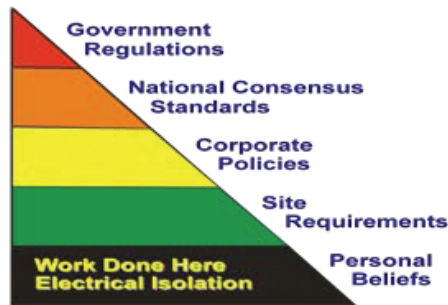

Figure 2

4. Zero Energy Verification – Is There Voltage

Electrical accidents are impossible without electrical energy. If an electrician comes into direct contact with electrical energy, there is a 5% fatality rate. Shocks and burns comprise the remaining 95%. The NFPA 70e is very specific on how to isolate electrical energy. First, all voltage sources must be located and labeled. Multiple voltage sources are commonplace today due to the proliferation of back-up generators and UPS's. Next, voltage testing devices must be validated using the LIVE-DEAD-LIVE procedure.⁴ Additionally, the voltage tester must also physically contact the voltage and must verify each phase voltage to ground.⁵

5. The RCH and Electrical Safety

How does the RCH apply to electrical safety?

1. **Elimination** – Removing all electrical energy exposure.
2. **Substitution** – Lowering the electrical energy exposure.
3. **Engineering Controls** – Reinventing ways to control electrical energy exposure.
4. **Awareness** – Revealing and labeling all sources of electrical energy.
5. **Administrative Controls** – Regulations that teach personnel safety around electrical energy.
6. **Personal Protection** – Reducing risks of working on live voltage.

Electrical workers are exposed to the greatest risks at the lower levels of the RCH. Recognizing that these “residual risks” are present; the NFPA 70e tells workers how to perform their work safely in spite of these risks. In fact a large portion of the NFPA 70e details how to best manage these risks through Awareness, Administration, and Personal Protection. *On the other hand, the greatest opportunity for risk reduction comes by focusing in the upper part of the RCH. Huge improvements in electrical safety will come by Eliminating Substituting, and Engineering solutions that manage electrical energy exposure.*

6. The Department of Energy (DOE)

For better insight into the RCH process, let's look at a 2005 Department of Energy report on their electrical safety record. This report cited six reasons for their 14.1 electrical incidents per month.

Within this DOE report, “hazard identification” [see Table 1 in Appendix A] stood out as an *administrative control* issue resulting in numerous electrical incidents. The solution was to get tougher administrators or look for improvements higher up in the RCH. Right above Administrative Controls (see Figure 1) we learn that increasing employee's *awareness* of electrical hazards will reduce these types of incidents. A potential solution is to label and mark all voltage sources (hazards) feeding the electrical system. Voltage indicators and voltage portals wired to each voltage source provides two benefits: It identifies the voltage source and provides a means to check the status of that voltage source without exposure to voltage. Apply the same process to “LOTO violations”:

7. Elimination: The Hall of Fame of Safety

We can enter the Electrical Safety Hall of Fame by finding ways to eliminate voltage exposure. Here are a few practical examples that can be implemented today:

- **Lock Out Tag-Out [LOTO]:** requiring LOTO procedures electricians to verify zero energy before performing mechanical maintenance needlessly exposes workers to voltage. Since all voltages do not create mechanical motion, thru-door voltage checking devices as part of a mechanical LOTO procedure will eliminate voltage exposure (see Appendix B).
- **Open a control panel?** What maintenance functions can be moved to the outside of the panel? Thru-door data access ports are becoming commonplace because they allow programming with the panel door closed (Figure 3). A more recent unmanaged Ethernet switch mounted outside the panel. This unique device allows full thru-door access for a worker to troubleshoot and reset the Ethernet switch mounted outside the panel. This unique device allows full thru-door access for a worker to trouble-shoot and reset the Ethernet switch (Figure 4). What other device can be re-engineered around thru-door electrical safety? Perhaps putting certain branch circuit breakers on the outside of the panel is a good application?
- **Control Panel Design:** Providing a physical separation between the power and control compartments within an enclosure may become a standard. Voltages under 50 volts are considered safe, so reducing the control power to 24VDC makes the control power section safe to work on while it is energized. These above examples are only 'scratching the surface', so I challenge you to find ways to eliminate voltage exposure.

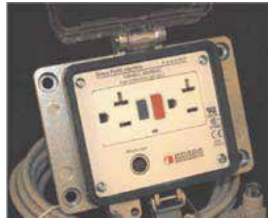

Figure 3



Figure 4

8. Conclusion

When safety works perfectly, nothing happens! When there is an incident or a close call the RCH should be an inspiration to find a better way. By applying the RCH principles to electrical safety risks, it will open our eyes to see more practical ways to reduce those risks. Perhaps, we would expend more resources finding electrical safety solutions that will provide both higher safety and productivity dividends.

Harold Pitney Brown intuitively knew that eliminating risks would save lives. He just got one detail wrong when he thought that 300 Volts was not a risk. Now for the rest of the story: To prove that AC voltage is more lethal than DC, Thomas Edison hired Harold Pitney Brown to develop the first electric chair that executed William Kemmler on August 6, 1890. So much for electrical safety!

9. Thru-Door Voltage Checking and Labeling

A 40+ year industrial electrician once said, "I like anything that keeps me from getting bit [shocked]!" Getting a dog or snake bite is always a surprise! Since voltage is invisible, most electrical accidents happen because the electrician is unaware of a voltage source. Therefore using every possible means of marking every voltage source within an electrical enclosure will go a long way to limit these surprises. Let's go a step further and make sure all voltage sources could be seen and tested from the outside of the electrical enclosure. This tells electricians the locations and the voltage states of all the electrical energy within an electrical panel.



Figure 5

10. Voltage Portals Improve Non-Contact Voltage Detectors

Within most of the common trades, many maintenance workers carry Non-Contact Voltage Detectors (NCVD) in their tool belts. Many times maintenance workers just need to know if there is power in a conductor. A NCVD is a simple, yet safe tool that checks voltage without physical contact with the current carrying conductor. When a NCVD is positioned close to an energized conductor between 90-1000VAC (50-500VAC), it beeps or flashes to indicate the presence of voltage. Still today many electricians carry sharpened voltmeter leads to stab into insulation to check the voltage when they can't easily get access to the bare conductor.

11. Label and Check Voltage with Voltage Portals

A voltage portal is a single voltage point encapsulated into a non-conductive housing mounted to the outside of an enclosure. With this, workers can check voltage inside the enclosure with a NCVD without being exposed to voltage. What if every voltage source within an enclosure was wired to a voltage portal? Then workers would not only be able to see every voltage source, but check their status prior to working on the panel.



Figure 6

12. A “False Negative” Is Deadly

Getting “bit” from live voltage is almost always a surprise! Far worse is an electrician starting to work on a conductor that he just tested “dead”, but actually is “live”. This is referred to as a “false negative” indication, which means that the voltage tester (falsely) indicated that there was no voltage (negative). The opposite scenario is a “false positive” which never hurt a soul. Because of this, NCVD’s have not been considered a reliable means in determining electrical isolation.

NCVD’s are a bit mysterious and because of the possibility of a false negative reading, some plants won’t allow maintenance workers to carry them. The following list details the many factors that affect the operation of a NCVD:

- AC only
- Minimum voltage level
- Phase cancellation
- Metal barriers (small enclosures)
- Underground cables
- Hand position
- Temperature
- Induced voltage
- Frequency

13. How it Works

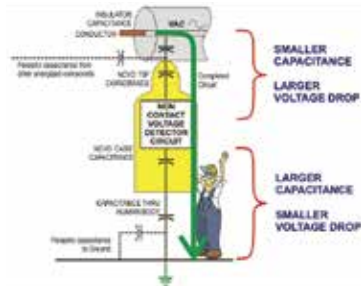

Figure 7

Figure 7 shows a typical NCVD checking a wire for voltage. When the NCVD is positioned next to an energized conductor, two capacitive circuits are created. A smaller capacitance exists between the energized conductor and the NCVD, while a larger capacitance exists between the NCVD through the worker’s body to ground. If voltage is applied across a capacitor, then the voltage drop

across a small capacitor is bigger than the voltage drop across a big capacitor. By comparing both of these voltages, the NCVD decides if the wire is energized. However, because this circuit is somewhat sensitive, other electrical energy within an enclosure will change the effective capacitance and ultimately the operation of NCVD. A false-negative reading is the worst case scenario when this stray “parasitic” capacitance changes too much the overall capacitance

circuit. However, if we can test that a completed electrical circuit exists then we will know that the conditions are ripe for the NCVD to properly sense voltages.

14. Testing Voltage Portal / Panel Combination

Once voltage portals are installed into a panel, they become the only permanent location on the outside of the panel where maintenance workers check voltages with NCVD’s. The correct design and installation of a voltage portal inherently limits the effects of parasitic capacitance and the opportunity for a false negative



Figure 8

reading. For example, to insure consistent and reliable voltage readings, the three voltage portals shown in Figure 8 are mounted to the side of panel with the wires routed away from other energized conductors.

Next, the control panel gets installed permanently into a facility. Once this is done, the capacitive circuit from the control panel to ground must be verified for a NCVD to reliably indicate voltage. Therefore, the entire voltage portal-panel combination can be tested as part of a written LOTO procedure to verify that a reliable capacitive circuit to ground exists when the control panel is energized.⁶

15. What is a Voltage Indicator?

The shocking truth is that voltages only become hazardous if you are able touch the live conductors (over 50Volts). A voltage indicator resides on the outside of an electrical panel and provides maintenance people the ability to see the voltages without opening the panel. Simply put, a voltage indicator is like a permanently connected voltmeter that personnel can see all the time. Seeing voltage through closed doors is a very safe idea.



Figure 9

Surprisingly most low voltage (under 600V) fatalities occur at 120V.⁷ Therefore in order for a voltage indicator to be truly effective in electrical safety, it must be able to indicate voltage between 50V and 600V. Furthermore, since most electrical systems have three-phases, a voltage indicator must be able to alert workers to voltage on any of the three phases. Therefore, a typical 3-phase voltage

indicator operates in a range of 40-750AC or 30-1000VDC with an earth ground connection (4-wires total). Voltage between any 2 wires will cause current to flow between phases thereby making the LED's flash (see Figure 9). Unless voltage is present there can be no shock hazard or a potential arc flash incident (electrical explosion due to a short circuit). Voltage is extremely lethal, so once an electrician disconnects power to the electrical system, they use a voltmeter to insure that electrical energy has been fully isolated before they begin work on the system. *Sometimes just checking voltage causes a short circuit which could lead to an arc flash explosion.*

A voltage indicator puts a redundant layer of protection between an electrician and live voltage. The ability to "pre-check" voltage before opening an electrical enclosure means that workers significantly reduce their exposure to voltage and offer these safety benefits:

- Reduction in arc flash incidents due to voltage checking.
- Saves time due to simplified LOTO.
- Checking voltage with a meter is the 4th leading cause of arc flash incidents.
- A voltage indication is a permanently wired 3-Phase 24/7 "Voltmeter" with a 20+ year life.
- Voltage indicators are self-powered from the line voltage, requires no batteries, and no maintenance.

By the time you physically contact raw electrical energy, most often it is too late. A thru-door voltage indicator offers a much needed level of safety over and above the traditional voltmeter and proper safety procedures.



Figure 10

16. Benefits of Combining Voltage Portals With Voltage Indicators

Both voltage indicators and voltage portals provide an independent means of checking voltage from the outside of an enclosure. Furthermore, these devices add less than \$160 to the cost of a panel. Under current NFPA 70e regulations accessing potentially live panels has become time consuming.

Using through panel voltage checking devices reduces risk of arc flash and shock and saves time. Note the comparison on Table 2.

17. Mechanical Lock-Out Tag-Out

Mechanical maintenance procedures require isolation of all energy sources (including electricity) before work begins on the piece of equipment. A typical procedure requires an electrician to access the live voltage section of the equipment to verify zero voltage. Since

a vast majority of electrical energy is converted into mechanical motion, the presence of voltage does not automatically guarantee mechanical motion because motors need a very specific power input for rotation to occur. For example, a three phase motor rotates only when it receives enough current and the correct voltages on all three phases.

All voltages do not create mechanical motion. Furthermore, control systems are designed to determine not only when a motor starts and stops, but if it is safe to do so.

Raw electrical energy has the ability to instantaneously cause shock injuries and damage to equipment in the event of an arc flash explosion. When electricity is confined within a mechanical system, it is inherently safer due to the system design. While 100% electrical isolation is beneficial for mechanical LOTO, it is not required to make a system mechanically safe.⁸ Therefore, a voltage indicator used in conjunction with proper procedures offers a reliable means to verify zero energy state for mechanical maintenance. No longer is an electrician put at risk to physically verify a zero electrical energy state prior to maintenance. A voltage indicator is a very simple device because it only indicates voltage, and therefore any worker is able to verify zero (less than 40VAC) energy prior to performing mechanical maintenance.

References

- 1 – "Should my Electrical Safety Program be Part of my Safety Program" (EWS2007-7) Landis, Floyd II PE originally presented this concept at the 2007 IEEE Electrical Safety Workshop.
- 2 - America National Standards Institute/American Industrial Hygiene Association Z10-2005A Occupational Health and Safety Management Systems
- 3 - Ray Jones was Chairman of the 2000 Edition of the NFPA 70E
- 4 - In this procedure, the voltage tester is checked to a known "live" voltage source, then checked to make sure that the panel is "dead" and lastly retested to another "live" voltage source to make sure the tester is still functioning.
- 5 - NFPA 70E (2009) 120.1(5), Annex G 3.4
- 6 - Mechanical LOTO
- 7 - Worker Death by Electrocution (Figure 10) NIOSH Publication No. 98-131; <http://www.cdc.gov/niosh/docs/98-131/epidemi>.
- 8 - In a three phase system, a motor would not rotate if one phase was energized.

Appendix C

Table 1

Causes of Incidents	Present RCH Principle		Increased Risk Reduction RCH Principle	
Lack of hazard identification.	Administrative	Properly administrating NFPA 70e requires all electrical enclosures to have warning labels with incident energy level (calories).	Awareness /Elimination	Marking all energy sources on the panel exterior provides personnel with simple yet safe hazard identification.
LO/TO violations including shortcuts or lack of energy verification.	Administrative	Can the LO/TO procedure be rewritten to reduce exposure to voltage?	Elimination /Substitution	Thru-door voltage pre-checking "eliminates" all exposure to voltage for mechanical LOTO* and provide significant risk reduction for electrical LOTO.
		Reducing electrical energy to Cat 0/1 will greatly reduce the potential arc flash energy	Substitution	Lowering the arc flash energy effectively 'substitutes' for a lower risk for a higher risk.

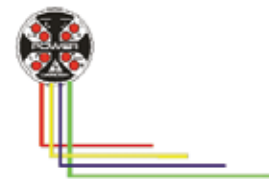

Table 2

Purpose	Multi-function	Voltage Only	Voltage Only
Powered by	Batteries	Passive/Batteries	Line Voltage
# of Phases	Single	3-phase/Single	3-phase
Hardwired	NO	YES	YES
Thru-Door	NO	YES	YES
Indication	Digital	Visual/Audible	Visual
Physical Action	YES	YES	NO
Live-Dead-Live	YES	YES	NO

Thru-Door Electrical Isolation Pre-Verification Application Note

24/7 Voltmeter and Voltage Indicator Comparison

Reduces Arc Flash & Increases Safety

A SafeSide® voltage indicator is a pushbutton-sized electrical safety device mounted to the outside of any electrical enclosure and wired internally to the primary incoming power source. The sole purpose of this device is to alert workers to the presence (or absence) of voltage with flashing LED's. Electrical safety is enhanced by properly applying voltage indicators and correctly incorporating them into an electrical safety procedure. The NFPA 70E impacts every aspect of workplace electrical safety, thereby providing maintenance personnel with a steady stream of new ideas, better procedures, and improved tools for electrical personnel. Electricians still rely on the good 'ol voltmeter to determine if an electrical system has been put into an electrically safe condition. A voltmeter and SafeSide® voltage indicator each have different yet similar functions, but still belong on the same "electrical safety" team. Let's compare and contrast both devices with the goal of understanding how each device can be used for maximum safety.

A SafeSide® Voltage Indicator:

- is permanently mounted and less susceptible to damage.
- has built-in reliability due to redundant circuitry, surge immunity, long life LEDs and heavy duty construction.
- has but one function, indicating voltage.
- gets its power from the line (hazardous) voltage, not from an external power source.
- is hardwired with pigtail leads which ensures a reliable connection.
- works well within a mechanical Lock-out Tag-out procedure.
- requires no fusing and easily installs in a 30mm hole.

**R-3W
Voltage
Indicator**

UL TYPE 4X
UL US
LISTED
IND. CONT. EQ.
6927
UL File: E256847



A Voltage Indicator:

Permanent Device:
Long life LED's with
redundant circuits*

Dedicated Device:
Voltage Indication only
(40-750VAC/30-1000VDC)

Powered all the time
from L1 or L2 or L3
(same voltage it indicates)

Integral leads hardwired
to voltage with no fuses**

4-wire device & permanent
earth ground reference

Thru-door phase indication
Installs in 30mm hole

A Voltmeter:

Portable Tool:
Shorter life-span &
susceptible to damage

Multiple functions:
Test device for AC/DC
voltage, OHM's

Powered when use
ON-OFF switch and
batteries needed

Temporary leads
with connectors

2-wire device

Must test
each phase

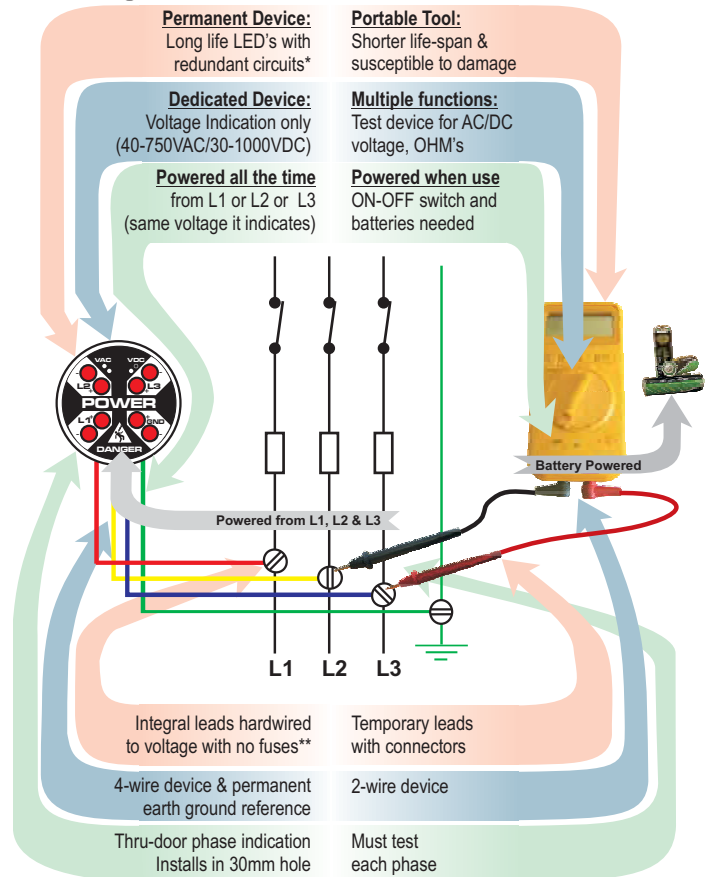

*Each phase has an LED flashing circuit for both the (+) and (-) side of the AC sine wave.

**The is UL Listed self-protected device with 6' leads. For most installations no fusing is required between the line and the R-3W.

ISOLATION VERIFICATION: SAFETY BENEFIT ANALYSIS FOR EXTERNALLY MOUNTED VOLTAGE INDICATORS (VI)^[1]

Analysis of the NFPA 70E Sample[2] Lock-out Tag-out Procedure (“Live-Dead-Live”)

NFPA 70E Annex G Reference	Key Concepts	Voltmeter Verification Only (No Voltage Indicator)	Voltage Indicator Safety Benefits ^[3] (in addition to Voltmeter Verification)	Comments & Clarifications Regarding NFPA 70E Procedure
6.1	Locate all electrical energy & stored energy sources	Panel Closed Voltmeter not part of the LOTO process until step 6.6	Visible indication of stored & electrical energy with door closed Provides instant critical power system status	For panels with multiple power sources, external VI(s) meet this requirement. Safety procedure needs to have personnel to view/inspect proper indication of the VI.
6.2	Physically operate the isolator: disconnect power & relieve stored energy		VI(s) warn if any AC or DC energy is still present after operating the isolator	Personnel to visually see the VI stop functioning and/or stored energy slowly dissipate.
6.3	Apply lockout device Employ additional safety measure (removing a circuit element)		VI still providing information	VI is an “additional safety measure”
6.4	Attempt to operate the isolator		A VI would indicate an isolator failure, if it “operates” and “reconnects” the power	VI provides immediate feedback to the operator
6.5	Inspect voltage detecting instrument for damage		Completed in 6.1	Verifying proper operation of VI in step 6.1 is critical to entire safety procedure
6.6	Verify proper operation of voltage detecting instrument, then test for absence of voltage	If not functioning: needs a battery or repair	Completed in 6.1 The VI provides voltage indication and relative voltage value ^[3]	The line voltage is the VI's only power source (no battery) therefore, if the VI is flashing there must be voltage(s) present inside the enclosure. Flash rate varies with voltage—lower voltage=lower flash rate.
6.7	Verify proper operation of voltage detecting instrument, after testing for absence of voltage		Completed in 6.2 Disconnect opens and VI ceases to operate	
6.8	Install grounding bars to eliminate induced voltages or stored energy		The VI is permanently wired providing ongoing indication if there is stored energy or induced voltages	

[1] For discussion purposes: “power source” is a 3-phase Wye-Delta with Earth Ground and SafeSide® R-3W.

[2] NFPA 70E, 2004 Edition, Annex G, 6.0-6.9

[3] The traditional “Live-Dead-Live” LOTO safety procedure with a voltmeter remains intact. These comments only describe the added safety benefits if a VI is employed in addition to existing LOTO procedure.

VOLTAGE INDICATOR Overcurrent Protection Application Note

Background:

The purpose of the NEC, as well as the UL 508A Industrial Control Panel Standard, is best summed up in Article 90 of the 2008 NEC:

“90.1 (A) Practical Safeguarding. The purpose of this Code is the practical **safeguarding of persons** and property from hazards arising from the use of electricity.”

“(B) Adequacy. This Code contains provisions that are considered necessary for safety. Compliance therewith and proper maintenance results in an **installation that is essentially free from hazards.**”

Compared to the purpose of the NFPA 70E:

“90.1 Purpose. The purpose of this standard is to provide a practical **safe working area** for employees relative to the hazards arising from the use of electricity.”

“90.2 Scope. (A) Covered. This standard addresses electrical safety requirements for **employee workplaces** that are necessary for the practical safeguarding of employees during activities such as the installation, operation, maintenance.”

These are two very different goals. While the NEC protects people using electricity and property, the NFPA 70E only protects employees who work with or around electricity. In very few instances these two objectives do not conflict, and when that occurs a hazard risk analysis needs to be performed to determine which solution poses the highest risk. Once this has been determined, we can decide how to resolve this conflict by focusing on reducing the greater risk first. Over-current protection (fusing) of a voltage indicator (VI) provides us with an excellent test case.

Blown Fuse is False Negative:

Getting bit by live voltage is almost always a surprise! Far worse is an electrician starting to work on a conductor that he just tested dead, but actually is live. This is referred to as a false negative indication, which means the voltage detector falsely indicated no voltage. Since the VI's only full time job is indicating voltage, a blown fuse on its input creates a false negative indication of voltage, which is a hazard. A fuse also adds four connection points of failure for each phase (line-load for fuse and fuse block). In electrical safety, **once you touch a live conductor there is ALWAYS an electric incident**

because electrical energy is instantaneous. Therefore, it is critical to avoid any chance of false-negatives.

Hazard Risk Analysis

Users need to determine the greater risk: The chance of a false negative voltage indication or a damaged or shorted 18AWG wire inside an enclosure?

The Increased Hazard Exception

The NFPA 70E recognizes that perfect safety does not exist and there is always a trade-off between safe and safer. For example, energized work shall be permitted where the employer can demonstrate that de-energizing introduces additional or increased hazards (NFPA 70E 130.1(A)(1)).

The NEC states that a wire without overcurrent protection is a lesser hazard than a non-functioning fire pump motor due to a blown fuse. A greater hazard exists when a building burns down because the fire pump motor doesn't start due to a blown fuse in the control circuit! *“Exception: Overcurrent protection shall be omitted where the opening of the control circuit would create a hazard as, for example, the control circuit of a fire pump motor and the like”* NEC 430.72(C)

The informational note in NEC 725.1 provides another example relating to proper installation of Class 1, 2, and 3 remote-control, signaling, and power limited circuits. These circuits have limited power outputs and characteristics that differentiate them from *electric light and power circuits*, so users may determine *“alternative requirements...with regard to... overcurrent protection, insulation requirements, and wiring methods and materials.”* In addition, *“Remote-control circuits for safety-control equipment shall be classified as Class 1 if the failure of the equipment to operate introduces a direct fire or life hazard [emphasis added]”* NEC 725.31(A).

In electrical safety, determining **zero electrical energy is critical**. Installing overcurrent protection for a VI installation increases the opportunity for a false negative reading thereby *potentially creating a greater hazard*. Transformers can be excluded from overcurrent protection for reasons specified in NEC 430.72(B), (C)(1) to (5). The construction and design of the VI creates fewer failure points and a higher degree of electrical integrity than transformers.

Over-current Protection Design Considerations

Fusing protects both the wires and the devices from permanent damage due to excessive current flow during a short circuit. Since VIs install between all 3-phases and ground, it is imperative that the failure of the VI does not create a bolted fault condition. Consider these design facts relating to fusing the:

High Impedance: SafeSide® VIs are UL Listed as Auxiliary Devices for use in a UL 508A industrial control panels or UL 845 motor control centers. UL performed a single component evaluation test that insures the device would not experience a catastrophic failure due to a component failure, thereby causing a direct short circuit

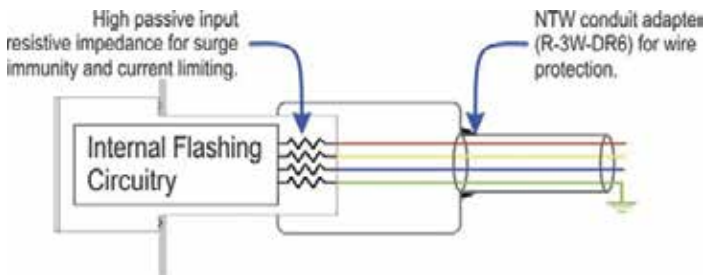

Figure 1

between phases. UL determined that VIs are a self-protected device whereby a single component failure draws no more than 3.7mA current at 750VAC applied to the device. The large passive input resistors on each phase of the VI provides this current limiting function with a nominal current draw of 300µA between phase at 480VAC.

Electrical Integrity: The potted construction adds additional electrical strength to the VI. The physical presence of high voltage only extends ¾" from the rear (inside) where the leads enter the device (Figure 1).

Surge Rated: The VI known as part number R-3W2 carries a CAT III (1000V) and CAT IV(600V) surge rating for reliability.

Integral Lead Wires: The integral potted 18AWG UL listed 1000V rated lead wires will not vibrate loose causing a short circuit to ground. Since the failure mode of the VI is 3.7mA, these wires should not fail due to a device failure.

Wire Protection: An optional NTW conduit adapter (R-3W-DR6) provides physical protection to the wires.

In conclusion, over-current protection will only protect VIs from a damaged lead wire that might short to ground or another bare

conductor. If this happens, most likely the current will vaporize the lead wire causing limited damage to the enclosure. Since the lead wire insulation is a flame-rated and UL-listed, it is designed to not sustain a flame. The UL installation sheets also state that overcurrent protection of the leads is not a requirement for every installation.

Other Installations Options: NECTap Rule and the UL 508A 12" Rule Approach

NEC 430.72(A), Table 430.72(B) allows smaller conductors to be tapped off larger branch circuits. In addition, the UL 508A 40.3.2 Exception 2 allows for unprotected leads less than 12" from the device. This gives you two installation options to consider:

- Mount the VI within 12" of the main disconnect. The best location is on the flange or the side of the enclosure. An NPT conduit adaptor (R-3W-NPT125) for the VI may facilitate some other creative mounting options.
- From the main disconnect, wire to terminal blocks as per the NEC tap rule. Locate the terminal blocks within 12" of the VI as per Figure 2.

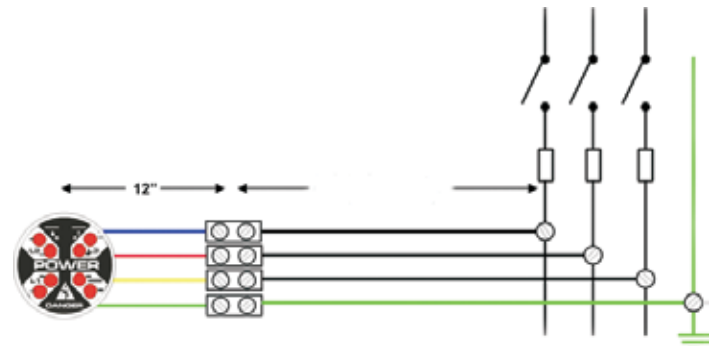

Figure 2

The NEC has been around a lot longer than the NFPA 70E. The writers of the NEC never envisioned that a safe electrical installation and electrical worker safety would conflict with each other. As shown in this write-up, these inconsistencies are usually mitigated with a little common sense and good logic.

***Products:** VI includes part numbers R-3W, R-3W2, R-3W-SR, and R-3F-Lxx. The same principles described herein apply to the voltage portal installations. Voltage Portals part number scheme included R-1A and R-T3.

VOLTAGE INDICATOR

UL Listing: R-3W2: UL File E334957, CCN:NOIV and E311256, CCN: PICQ (UL 61010-1). R-3W, R-3F-Lxx, and R-3W-SR: UL File E256847, CCN NKCR.

NOTE:

Short Circuit Current Rating (SCCR) tells the user how much instantaneous short circuit current can pass through a device without permanent damage. Devices that supply current to other devices in normal operation, can have an SCCR rating. SafeSide® VIs do not have a SCCR rating because they are wired between all three phases and are effectively in a shorted condition when energized. If a short circuit occurs in a system where an VI is installed, the high currents passing through the system will not find a path through the VI and the current flow would not cause any damage to the device. Therefore the SCCR rating is not applicable.

Application Standards: UL508A February, 2010 National Electrical Code (NEC) NFPA 70 - 2008 Edition, NFPA 70E - 2009 Edition, and CSA Z 462

Burnie & Les

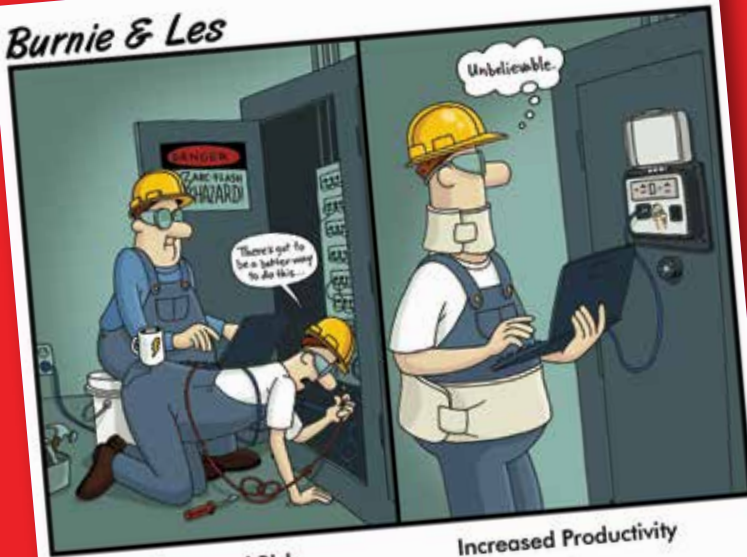

Increased Risk

Increased Productivity

THRU DOOR

GracePorts®: Your all-in-one device for Safety, Convenience and Productivity

Believe it or not, there's a better way. GracePorts® provide safe and convenient way to access control panels through closed doors. These fully customizable communication ports make performing routine tasks more efficient and comfortable by providing peace of mind. Thru-door access enhances compliance to NFPA 70E / CSA Z462 as well as global electrical safety standards. When you use GracePorts, you'll never have to compromise the safety of workers like our pal, Burnie.



GracePorts®

800.280.9517



CHS Controls AB
Tel +46 42 38 61 00, Fax +46 42 38 61 29
chs@chscontrols.se www.chscontrols.se



Inside Sales / Technical Questions

Phone: 800-280-9517

Fax : 563-386-9639

Email: sales@grace-eng.com

Davenport, IA 52807, USA

www.graceport.com

Purchase Orders

Fax : 563-386-9639

Email: orders@grace-eng.com



CHS Controls AB

Tel +46 42 38 61 00, Fax +46 42 38 61 29

chs@chscontrols.se www.chscontrols.se