

SL Series Stacklights



E26 Series Stacklights



2.1 SL Series

Product Description	V7-T2-2
Features	V7-T2-2
Benefits	V7-T2-2
Standards and Certifications	V7-T2-2
Product Overview	V7-T2-3
Component Identification—SL7	V7-T2-4
Product Selection—SL7	V7-T2-6
Component Identification—SL4	V7-T2-12
Product Selection—SL4	V7-T2-14
Accessories	V7-T2-19
Technical Data and Specifications	V7-T2-20
Dimensions	V7-T2-25

2.2 E26 Series

Product Description	V7-T2-32
Features	V7-T2-32
Benefits	V7-T2-32
Standards and Certifications	V7-T2-32
Product Identification	V7-T2-33
Catalog Number Selection	V7-T2-34
Product Selection	V7-T2-35
Replacement Parts	V7-T2-40
Technical Data and Specifications	V7-T2-41
Ratings	V7-T2-42
Mounting Instructions	V7-T2-43
Dimensions	V7-T2-44

Stacklights—SL Series

2



Product Description

The new Eaton SL7 and SL4 stacklights provide reliable control over all key processes and machine availability. Now available in two sizes, 70 mm (SL7) and 40 mm (SL4), the new stacklights are engineered to keep you informed about potential material requirements, downtime and hazards. Modules are available in a wide selection of audible, illuminating and mounting options that are well suited to adapt to any industrial application.

Highly Modular and Versatile Line

- Easily configurable components
- Simple bayonet mounting mechanism for quick assembly
- Flexible mounting and lighting options
- Volume-adjustable alarms

Optimal Performance in Rugged Applications

- All elements have IP66 and UL Type 4/4X/13 ratings for protection against strong jets of water
- Bright and efficient LEDs with a lifespan of up to 100,000 hours
- High-performance LEDs for maximum illumination in direct sunlight
- Acoustic modules with up to 100 dB sound levels
- Operating temperatures: -22° to +140°F (-30° to +60°C)

Contents

Description

	<i>Page</i>
SL Series	
Product Overview	V7-T2-3
Component Identification—SL7	V7-T2-4
Product Selection—SL7	V7-T2-6
Component Identification—SL4	V7-T2-12
Product Selection—SL4	V7-T2-14
Accessories	V7-T2-19
Technical Data and Specifications	V7-T2-20
Dimensions	V7-T2-25

Features

- Six lens colors: red, amber, yellow, green, blue, white
- Continuous, flashing, strobe and multi-strobe lighting functions
- Mono-tone, dual-tone and multi-tone audible alarms
- LED or incandescent lighting options
- Control up to five modules on a single stack, 10 with dual-arm base
- 24V, 120 Vac and 230 Vac operating voltages

Benefits

- Simplified twist-and-lock assembly, no tools required
- Compact components reduce inventory requirements and increase flexibility
- Versatile hardware for quick installation and minimized downtime
- New slim 40 mm size is ideal for applications with constrained space
- Lean automation with SmartWire-DT connectivity
- Ideal for indoor and outdoor usage

Standards and Certifications

- UL 508—File No. E29184
- IEC/EN 60947-5-1
- CSA C22.2 No. 14-10
- CSA C22.2 No. 94-91
- CSA Class No. NKCR7



Product Overview

	SL7	SL4
Diameter	70 mm	40 mm
		
Acoustic Modules	Page V7-T2-9	Page V7-T2-16
		
Light Modules	Continuous light, LED: Page V7-T2-6 Flashing light, LED: Page V7-T2-7 Strobe light, LED: Page V7-T2-7 Continuous light, high-performance LED: Page V7-T2-8 Strobe light, high-performance LED: Page V7-T2-8 Multi-strobe light, high-performance LED: Page V7-T2-8 Continuous light, Incandescent: Page V7-T2-8	Continuous light, LED: Page V7-T2-16 Flashing light, LED: Page V7-T2-15 Strobe light, LED: Page V7-T2-15 Multi-strobe light, LED: Page V7-T2-17 Continuous light, Incandescent: Page V7-T2-17
		
		
Base Modules	Page V7-T2-10, V7-T2-11	Page V7-T2-17
Accessories	Page V7-T2-19	Page V7-T2-19

2.1

Stacklights

SL Series

Component Identification—SL7

2

Component Identification

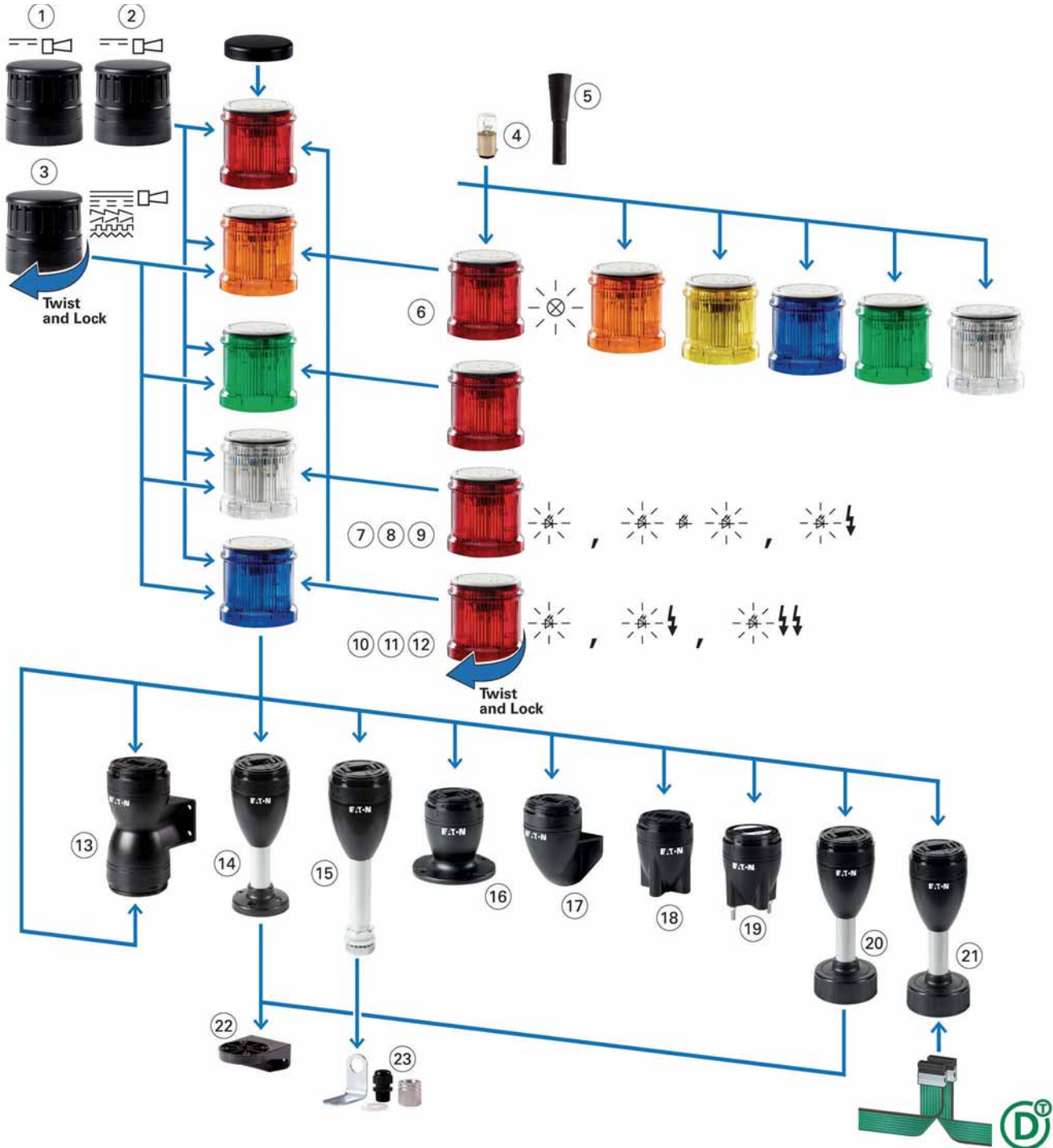

Light Modes

	Continuous	Flashing	Strobe	Multi-Strobe
Incandescent		—	—	—
LED				

SL7—Component Identification Descriptions

Item	Item Number	Description	Page Reference
Acoustic Modules			
Easy mounting with bayonet mount, place at highest position Sound pressure up to 100 dB, adjustable with internal potentiometer Operating mode: 100% DF (duty factor) Degree of protection: UL Type 4/4X/13, IP66 Operational voltages: 24 Vac/Vdc, 110/120 Vac, 230/240 Vac	1	Continuous tone or pulsed tone, adjustable with internal DIP switches Frequency: 2800 Hz	V7-T2-9
	2	Continuous tone or pulsed tone; can be actuated externally; takes up to two inputs (two modules) Frequency: 2800 Hz	V7-T2-9
	3	Multi-tone (eight tones) adjustable with internal DIP switch Frequency 500–2700 Hz	V7-T2-9
Incandescent Bulb	4	Accessory	V7-T2-19
Tool for Replacing Incandescent Bulb	5	Accessory	V7-T2-19
Light Modules			
Easy mounting with bayonet mount, modules can be arranged in any order Operating mode: 100% DF (duty factor) Degree of protection: UL Type 4/4X/13, IP66 Max. 5 modules per stack or up to 10 via dual-arm base option			
Light Module for Incandescent Bulb			
Continuous light	6	BA15d socket, without incandescent bulb	V7-T2-7
Light Modules with LED			
Continuous light	7		V7-T2-6
Flashing light	8	Flashing frequency: 2 Hz	V7-T2-7
Strobe light	9	Flashing frequency: 1.4 Hz	V7-T2-7
Light Modules with High-Output LED			
Continuous light	10		V7-T2-8
Strobe light	11	High-performance LED, flashing frequency: 1.4 Hz	V7-T2-8
Strobe light, multi-strobe light	12	High-performance LED, with various strobe sequences Flashing frequency: 1–2.6 Hz	V7-T2-8
Base Modules			
Easy mounting with bayonet mount, includes cover plate, with spring-cage terminals Degree of protection: UL Type 4/4X/13, IP66			
Base for mounting on both sides	13	Max. 2 x 5 modules that can be actuated individually	V7-T2-11
Base with aluminum tube and plastic foot	14	Aluminum tube 100 mm, 250 mm or 400 mm	V7-T2-10
Base with aluminum tube and M20 thread	15	Aluminum tube 100 mm, 250 mm or 400 mm	V7-T2-10
Base with external fixing holes	16	—	V7-T2-10
Vertical base with bracket	17	—	V7-T2-11
Base with internal (on the inside) fixing holes	18	—	V7-T2-10
Base with built-in fixing screws (pre-assembled)	19	—	V7-T2-10
Base with base adapter for slipping onto place (rapid mounting and wiring system)	20	Aluminum tube 100 mm, 250 mm or 400 mm	V7-T2-10
Base with base adapter for slipping onto place (rapid mounting and wiring system) and SmartWire-DT™ connection	21	Aluminum tube 100 mm	V7-T2-10
Mounting Bracket			
Bracket	22	Accessory	V7-T2-19
Bracket	23	Accessory, includes M20 cable gland	V7-T2-19

2.1

Stacklights

SL Series

Product Selection—SL7

Complete Devices

2

SL7-100-L-R_



Continuous Light, LED, UL Type 4/4X/13, IP66

Rated Operational Voltage (U _e V)	Number of Modules	Color	Function	Standard Pack	Catalog Number
Base Module with Foot and 100 mm Tube					
24 Vac/Vdc	2	Red/Green		1	SL7-100-L-RG-24LED
	3	Red/Amber/Green			SL7-100-L-RAG-24LED

Light Module with LED

SL7-L_



Continuous Light, UL Type 4/4X/13, IP66

Rated Operational Voltage (U _e V)	Color	Function	Standard Pack	Catalog Number
24 Vac/Vdc	Blue		1	SL7-L24-B
	Green			SL7-L24-G
	Red			SL7-L24-R
	White			SL7-L24-W
	Yellow			SL7-L24-Y
	Amber			SL7-L24-A
110/120 Vac	Blue		1	SL7-L120-B
	Green			SL7-L120-G
	Red			SL7-L120-R
	White			SL7-L120-W
	Yellow			SL7-L120-Y
	Amber			SL7-L120-A
230/240 Vac	Blue		1	SL7-L230-B
	Green			SL7-L230-G
	Red			SL7-L230-R
	White			SL7-L230-W
	Yellow			SL7-L230-Y
	Amber			SL7-L230-A

Light Module with LED, continued

SL7-BL_

Flashing Light, UL Type 4/4X/13, IP66, 2 Hz



Rated Operational Voltage (U _e V)	Color	Function	Standard Pack	Catalog Number
24 Vac/Vdc	Blue		1	SL7-BL24-B
	Green			SL7-BL24-G
	Red			SL7-BL24-R
	White			SL7-BL24-W
	Yellow			SL7-BL24-Y
	Amber			SL7-BL24-A
	110/120 Vac	Blue		
Green			SL7-BL120-G	
Red			SL7-BL120-R	
White			SL7-BL120-W	
Yellow			SL7-BL120-Y	
Amber			SL7-BL120-A	
230/240 Vac		Blue		1
	Green		SL7-BL230-G	
	Red		SL7-BL230-R	
	White		SL7-BL230-W	
	Yellow		SL7-BL230-Y	
	Amber		SL7-BL230-A	

SL7-FL_

Strobe Light, UL Type 4/4X/13, IP66, 1.4 Hz



Rated Operational Voltage (U _e V)	Color	Function	Standard Pack	Catalog Number
24 Vac/Vdc	Blue		1	SL7-FL24-B
	Green			SL7-FL24-G
	Red			SL7-FL24-R
	White			SL7-FL24-W
	Yellow			SL7-FL24-Y
	Amber			SL7-FL24-A
	110/120 Vac	Blue		
Green			SL7-FL120-G	
Red			SL7-FL120-R	
White			SL7-FL120-W	
Yellow			SL7-FL120-Y	
Amber			SL7-FL120-A	
230/240 Vac		Blue		1
	Green		SL7-FL230-G	
	Red		SL7-FL230-R	
	White		SL7-FL230-W	
	Yellow		SL7-FL230-Y	
	Amber		SL7-FL230-A	

2.1

Stacklights

SL Series

2

SL7 Light Module with High-Output LED

SL7-L24-

Continuous Light, UL Type 4/4X/13, IP66



Rated Operational Voltage (U _e V)	Color	Function	Standard Pack	Catalog Number
High-Performance LED for Maximum Signaling Effect				
24 Vac/Vdc	Blue		1	SL7-L24-B-HP
	Green			SL7-L24-G-HP
	Red			SL7-L24-R-HP
	White			SL7-L24-W-HP
	Yellow			SL7-L24-Y-HP
	Amber			SL7-L24-A-HP

SL7-FL24- -HP

Strobe Light, UL Type 4/4X/13, IP66



Rated Operational Voltage (U _e V)	Color	Function	Standard Pack	Catalog Number
High-Performance LED for Maximum Signaling Effect, 1.4 Hz				
24 Vac/Vdc	Blue		1	SL7-FL24-B-HP
	Green			SL7-FL24-G-HP
	Red			SL7-FL24-R-HP
	White			SL7-FL24-W-HP
	Yellow			SL7-FL24-Y-HP
	Amber			SL7-FL24-A-HP

SL7-FL24- -HPM

Multi-Strobe Light, UL Type 4/4X/13, IP66



Rated Operational Voltage (U _e V)	Color	Function	Standard Pack	Catalog Number
High-Performance LED for Maximum Signaling Effect, 1–2.6 Hz				
24 Vac/Vdc	Blue		1	SL7-FL24-B-HPM
	Green			SL7-FL24-G-HPM
	Red			SL7-FL24-R-HPM
	White			SL7-FL24-W-HPM
	Yellow			SL7-FL24-Y-HPM
	Amber			SL7-FL24-A-HPM

SL7 Light Module for Incandescent Bulb

SL7-L-

Continuous Light, UL Type 4/4X/13, IP66

For incandescent bulb selection, see **Page V7-T2-19**.





Rated Operational Voltage (U _e V)	Color	Function	Standard Pack	Catalog Number
Without Light Elements, Incandescent Bulb, Maximum 7W				
<250 Vac/Vdc	Blue		1	SL7-L-B
	Green			SL7-L-G
	Red			SL7-L-R
	White			SL7-L-W
	Yellow			SL7-L-Y
	Amber			SL7-L-A

SL7 Acoustic Modules

SL7-AP_

**Continuous Tone or Pulsed Tone, UL Type 4/4X/13, IP66** ①



Adjustable with internal DIP switches.
Sound pressure 100 dB, adjustable with internal potentiometer.
 $f = 2800$ Hz.

Rated Operational Voltage (U_e V)	Rated Operational Current (I_e mA)	Color	Function	Sound Type	Standard Pack	Catalog Number
24 Vac/Vdc	Maximum 92	Black			1	SL7-AP24
110/120 Vac	Maximum 41	Black				SL7-AP120
230/240 Vac	Maximum 43	Black				SL7-AP230

SL7-AP_-E

**Continuous Tone or Pulsed Tone, External Actuation, UL Type 4/4X/13, IP66** ①



Assigned two inputs (two modules).
Sound pressure 100 dB, adjustable with internal potentiometer.
 $f = 2800$ Hz.

Rated Operational Voltage (U_e V)	Rated Operational Current (I_e mA)	Color	Function	Sound Type	Standard Pack	Catalog Number
24 Vac/Vdc	Maximum 92	Black			1	SL7-AP24-E
110/120 Vac	Maximum 41	Black				SL7-AP120-E
230/240 Vac	Maximum 43	Black				SL7-AP230-E

SL7-AP_-M

**Multi-Tone; Eight Tones, UL Type 4/4X/13, IP66** ①

Adjustable with internal DIP switch.
Sound pressure 100 dB, adjustable with internal potentiometer.
 $f = 500$ – 2700 Hz.

Rated Operational Voltage (U_e V)	Rated Operational Current (I_e mA)	Color	Function	Sound Type	Standard Pack	Catalog Number
24 Vac/Vdc	Maximum 115	Black			1	SL7-AP24-M
110/120 Vac	Maximum 45	Black				SL7-AP120-M
230/240 Vac	Maximum 43	Black				SL7-AP230-M

Note

① Place only at the highest position on a pole.

2.1





Stacklights

SL Series

SL7 Base Modules



2

For Horizontal Mounting—Includes Cover, Maximum 5 Modules

	Description	Tube Length	Color	Standard Pack	For use with ...	Catalog Number
	Base with aluminum tube and plastic foot Spring-loaded terminals	100 mm	Black	1	SL7-L-...	SL7-CB-100
		250 mm	aluminum color tube		SL7-BL-...	SL7-CB-250
		400 mm			SL7-FL-...	SL7-CB-400
	Base with aluminum tube and M20 threaded base Spring-loaded terminals	100 mm	Black	1	SL7-L-...	SL7-CB-T-100
		250 mm	aluminum color tube		SL7-BL-...	SL7-CB-T-250
		400 mm			SL7-FL-...	SL7-CB-T-400
	Base with internal (on the inside) fixing holes Spring-loaded terminals	—	Black	1	SL7-L-... SL7-BL-... SL7-FL-... SL7-AP-...	SL7-CB-IMH
	Base with built-in (pre-assembled) fixing screws Spring-loaded terminals	—	Black	1	SL7-L-... SL7-BL-... SL7-FL-... SL7-AP-...	SL7-CB-IMS
	Base with external fixing holes Spring-loaded terminals	—	Black	1	SL7-L-... SL7-BL-... SL7-FL-... SL7-AP-...	SL7-CB-EMH

SL7 Base Modules, continued

For Horizontal Mounting—Includes Cover, Maximum 5 Modules, continued

	Description	Tube Length	Color	Standard Pack	For use with ...	Catalog Number
SL7-FMS_ 	Base with base adapter for slipping onto place (rapid mounting and wiring system) Screw terminals	100 mm	Black	1	SL7-L-...	SL7-FMS-100
		250 mm	aluminum color tube		SL7-BL-...	SL7-FMS-250
		400 mm			SL7-FL-... SL7-AP-...	SL7-FMS-400
SL7-SWD  	Base with base adapter for slipping onto place (rapid mounting and wiring system) Blade terminal SWD4-8MF2 Maximum 0.3A per module External power supply connectable (24 Vdc) Configurable with SWD-Assist (planning and ordering help)	100 mm	—	1	SL7-L-... SL7-BL-... SL7-FL-... SL7-AP-...	SL7-SWD

SL7-CB-FW For Vertical Mounting—Includes Cover, Maximum 5 Modules

	Description	Color	Standard Pack	For use with ...	Catalog Number
	Vertical base with bracket Spring-loaded terminals	Black	1	SL7-L-... SL7-BL-... SL7-FL-... SL7-AP-...	SL7-CB-FW

SL7-CB-D For Mounting on Both Sides—Includes Cover, Maximum 2 x 5 Modules

	Description	Color	Standard Pack	For use with ...	Catalog Number
	Base with external fixing holes Spring-loaded terminals	Black	1	SL7-L-... SL7-BL-... SL7-FL-... SL7-AP-...	SL7-CB-D

2.1

Stacklights

SL Series

Component Identification—SL4

Component Identification

2

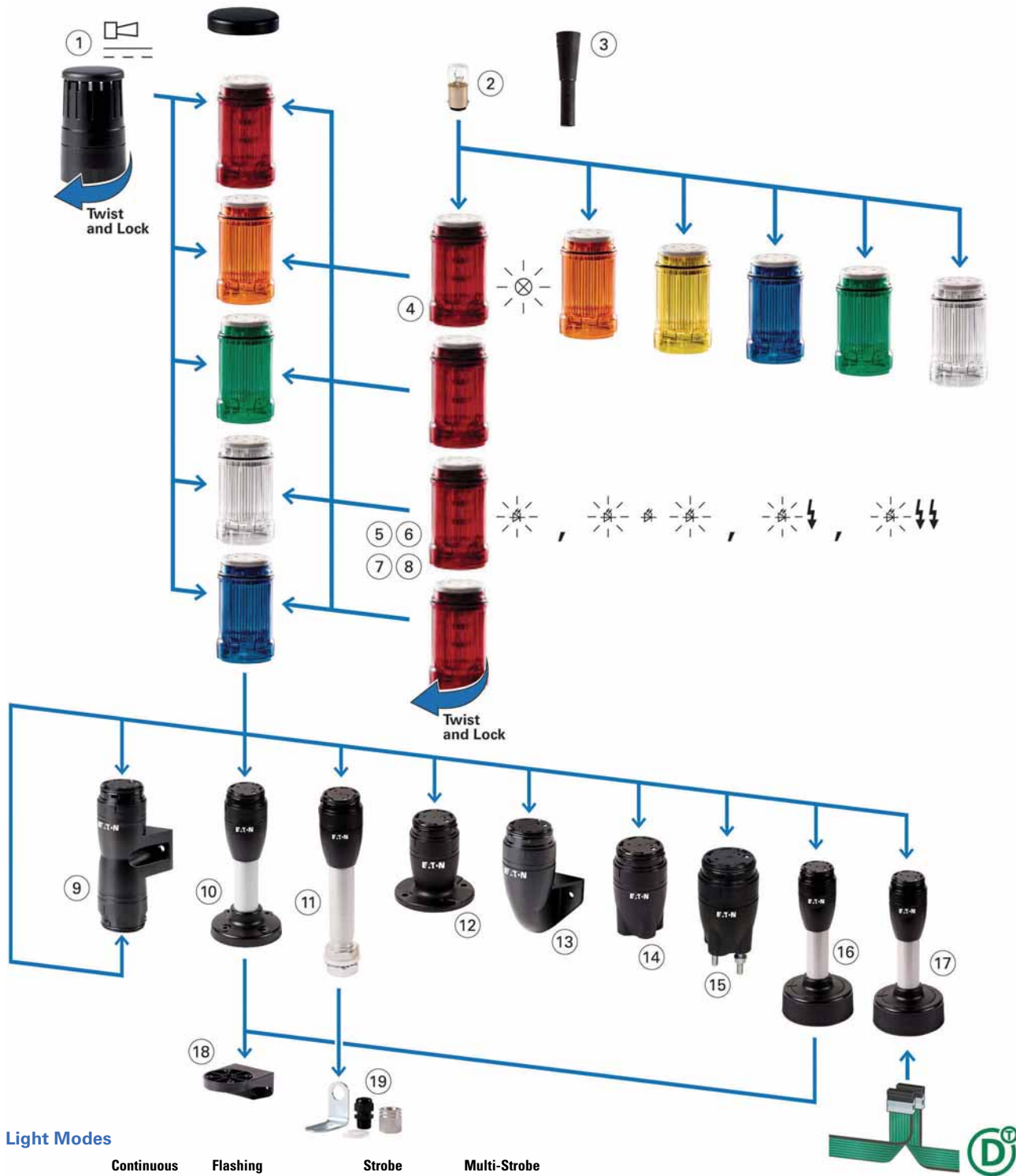

Light Modes

	Continuous	Flashing	Strobe	Multi-Strobe
Incandescent		—	—	—
LED				

SL4—Component Identification Descriptions

Item	Item Number	Description	Page Reference
Acoustic Modules			
Sound pressure 80 dB, adjustable with internal potentiometer, frequency 4000 Hz Easy mounting with bayonet mount, set up as highest module Permanently integrated cover plate Operating mode: 100% DF (duty factor) Degree of protection: UL Type 4/4X/13, IP66	1	Continuous tone or pulsed tone, adjustable with internal DIP switches Frequency: 2800 Hz	V7-T2-16
Incandescent Bulb	2	Accessory	V7-T2-19
Tool for Replacing Incandescent Bulb	3	Accessory	V7-T2-19
Light Modules			
Easy mounting with bayonet mount, modules can be arranged in any order Without light element (incandescent bulb with BA15d socket), easy mounting with bayonet mount. Operating mode: 100% DF (duty factor) Flashing frequency 2 Hz Degree of protection: UL Type 4/4X/13, IP66			
Light Module for Incandescent Bulb			
Continuous light	4	BA15d socket, without incandescent bulb	V7-T2-16
Light Modules with LED			
Continuous light	5		V7-T2-14
Flashing light	6	Flashing frequency: 2 Hz	V7-T2-15
Strobe light	7	Flashing frequency: 1.4 Hz	V7-T2-15
Strobe light, multi-strobe light	8	High-performance LED, with various strobe sequences Flashing frequency: 1–2.6 Hz	V7-T2-16
Base Modules			
Easy mounting with bayonet mount, includes cover plate, with spring-cage terminals Degree of protection: UL Type 4/4X/13, IP66			
Base for mounting on both sides	9	Max. 2 x 5 modules that can be actuated individually	V7-T2-17
Base with aluminum tube and plastic foot	10	Aluminum tube 100 mm, 250 mm or 400 mm	V7-T2-17
Base with aluminum tube and M20 thread	11	Aluminum tube 100 mm, 250 mm or 400 mm	V7-T2-17
Base with external fixing holes	12	—	V7-T2-17
Vertical base with bracket	13	—	V7-T2-17
Base with internal (on the inside) fixing holes	14	—	V7-T2-17
Base with built-in fixing screws (pre-assembled)	15	—	V7-T2-17
Base with base adapter for slipping onto place (rapid mounting and wiring system)	16	Aluminum tube 100 mm, 250 mm or 400 mm	V7-T2-17
Base with base adapter for slipping onto place (rapid mounting and wiring system) and SmartWire-DT™ connection	17	Aluminum tube 100 mm	V7-T2-17
Mounting Bracket			
Bracket	18	Accessory	V7-T2-19
Bracket	19	Accessory, includes M20 cable gland	V7-T2-19

2.1

Stacklights

SL Series

Product Selection—SL4

2

Complete Devices

SL4-100-L-R_



Continuous Light, LED, UL Type 4/4X/13, IP66

Rated Operational Voltage (U _e V)	Number of Modules	Color	Function	Standard Pack	Catalog Number
Base Module with Foot and 100 mm Tube					
24 Vac/Vdc	2	Red/Green		1	SL4-100-L-RG-24LED
	3	Red/Amber/Green		SL4-100-L-RAG-24LED	

Light Module with LED

SL4-L_



Continuous Light, UL Type 4/4X/13, IP66

Rated Operational Voltage (U _e V)	Color	Function	Standard Pack	Catalog Number
24 Vac/Vdc	Blue		1	SL4-L24-B
	Green			SL4-L24-G
	Red			SL4-L24-R
	White			SL4-L24-W
	Yellow			SL4-L24-Y
	Amber			SL4-L24-A
110/120 Vac	Blue		1	SL4-L120-B
	Green			SL4-L120-G
	Red			SL4-L120-R
	White			SL4-L120-W
	Yellow			SL4-L120-Y
	Amber			SL4-L120-A
230/240 Vac	Blue		1	SL4-L230-B
	Green			SL4-L230-G
	Red			SL4-L230-R
	White			SL4-L230-W
	Yellow			SL4-L230-Y
	Amber			SL4-L230-A

Light Module with LED, continued

SL4-BL_

Flashing Light, UL Type 4/4X/13, IP66, 2 Hz



Rated Operational Voltage (U _e V)	Color	Function	Standard Pack	Catalog Number
24 Vac/Vdc	Blue		1	SL4-BL24-B
	Green			SL4-BL24-G
	Red			SL4-BL24-R
	White			SL4-BL24-W
	Yellow			SL4-BL24-Y
	Amber			SL4-BL24-A
110/120 Vac	Blue		1	SL4-BL120-B
	Green			SL4-BL120-G
	Red			SL4-BL120-R
	White			SL4-BL120-W
	Yellow			SL4-BL120-Y
	Amber			SL4-BL120-A
230/240 Vac	Blue		1	SL4-BL230-B
	Green			SL4-BL230-G
	Red			SL4-BL230-R
	White			SL4-BL230-W
	Yellow			SL4-BL230-Y
	Amber			SL4-BL230-A

SL4-FL_

Strobe Light, UL Type 4/4X/13, IP66, 1.4 Hz



Rated Operational Voltage (U _e V)	Color	Function	Standard Pack	Catalog Number
24 Vac/Vdc	Blue		1	SL4-FL24-B
	Green			SL4-FL24-G
	Red			SL4-FL24-R
	White			SL4-FL24-W
	Yellow			SL4-FL24-Y
	Amber			SL4-FL24-A
110/120 Vac	Blue		1	SL4-FL120-B
	Green			SL4-FL120-G
	Red			SL4-FL120-R
	White			SL4-FL120-W
	Yellow			SL4-FL120-Y
	Amber			SL4-FL120-A
230/240 Vac	Blue		1	SL4-FL230-B
	Green			SL4-FL230-G
	Red			SL4-FL230-R
	White			SL4-FL230-W
	Yellow			SL4-FL230-Y
	Amber			SL4-FL230-A

2.1

Stacklights

SL Series

Light Module with LED, continued

2

SL4-FL24-_-M



Multi-Strobe Light, UL Type 4/4X/13, IP66

Rated Operational Voltage (U _e V)	Color	Function	Standard Pack	Catalog Number
LED for Effective Signaling Effect With Various Strobe Sequences, 1–2.6 Hz				
24 Vac/Vdc	Blue		1	SL4-FL24-B-M
	Green			SL4-FL24-G-M
	Red			SL4-FL24-R-M
	White			SL4-FL24-W-M
	Yellow			SL4-FL24-Y-M
	Amber			SL4-FL24-A-M

SL4 Light Module for Incandescent Bulb

SL4-L-_-



Continuous Light, UL Type 4/4X/13, IP66

For incandescent bulb selection, see **Page V7-T2-19**.

Rated Operational Voltage (U _e V)	Color	Function	Standard Pack	Catalog Number
Without Light Elements, Incandescent Bulb, Maximum 4W				
<250 Vac/Vdc	Blue		1	SL4-L-B
	Green			SL4-L-G
	Red			SL4-L-R
	White			SL4-L-W
	Yellow			SL4-L-Y
	Amber			SL4-L-A

SL4 Acoustic Modules

SL4-AP-_-



Continuous Tone or Pulsed Tone, UL Type 4/4X/13, IP66

Adjustable with internal DIP switches.





Sound pressure 80 dB, adjustable with internal potentiometer.

f = 4000 Hz.

Rated Operational Voltage (U _e V)	Rated Operational Current (I _e mA)	Color	Function	Sound Type	Standard Pack	Catalog Number
Place only at the highest position on a pole.						
24 Vac/Vdc	Maximum 39	Black			1	SL4-AP24
110/120 Vac	Maximum 21	Black				SL4-AP120
230/240 Vac	Maximum 21	Black				SL4-AP230

SL4 Base Modules

For Horizontal Mounting—Includes Cover, Maximum 5 Modules

	Description	Tube Length	Color	Standard Pack	For use with ...	Catalog Number
	Base with aluminum tube and plastic foot Spring-loaded terminals	100 mm	Black	1	SL4-L-...	SL4-PIB-100
		250 mm	aluminum color tube		SL4-BL-...	SL4-PIB-250
		400 mm			SL4-FL-...	SL4-PIB-400
	Base with aluminum tube and M20 threaded base Spring-loaded terminals	100 mm	Black	1	SL4-L-...	SL4-PIB-T-100
		250 mm	aluminum color tube		SL4-BL-...	SL4-PIB-T-250
		400 mm			SL4-FL-...	SL4-PIB-T-400
	Base with internal (on the inside) fixing holes Spring-loaded terminals	—	Black	1	SL4-L-... SL4-BL-... SL4-FL-... SL4-AP-...	SL4-PIB-IMH
	Base with built-in (pre-assembled) fixing screws Spring-loaded terminals	—	Black	1	SL4-L-... SL4-BL-... SL4-FL-... SL4-AP-...	SL4-PIB-IMS
	Base with external fixing holes Spring-loaded terminals	—	Black	1	SL4-L-... SL4-BL-... SL4-FL-... SL4-AP-...	SL4-PIB-EMH

2.1



Stacklights

SL Series

SL4 Base Modules, continued

2

For Horizontal Mounting—Includes Cover, Maximum 5 Modules, continued

Description	Tube Length	Color	Standard Pack	For use with ...	Catalog Number
SL4-FMS_  Base with base adapter for slipping onto place (rapid mounting and wiring system) Screw terminals	100 mm	Black	1	SL4-L-...	SL4-FMS-100
	250 mm	aluminum color tube		SL4-BL-... SL4-FL-...	SL4-FMS-250
	400 mm			SL4-AP-...	SL4-FMS-400
SL4-SWD   Base with base adapter for slipping onto place (rapid mounting and wiring system) Blade terminal SWD4-8MF2 Maximum 0.3A per module External power supply connectable (24 Vdc) Configurable with SWD-Assist (planning and ordering help)	100 mm	—	1	SL4-L-... SL4-BL-... SL4-FL-... SL4-AP-...	SL4-SWD

SL4-PIB-FW

For Vertical Mounting—Includes Cover, Maximum 5 Modules

Description	Color	Standard Pack	For use with ...	Catalog Number
 One-sided base with bracket Spring-loaded terminals	Black	1	SL4-L-... SL4-BL-... SL4-FL-... SL4-AP-...	SL4-PIB-FW

SL4-PIB-D

For Mounting on Both Sides—Includes Cover, Maximum 2 x 5 Modules

Description	Color	Standard Pack	For use with ...	Catalog Number
 Base with external fixing holes Spring-loaded terminals	Black	1	SL4-L-... SL4-BL-... SL4-FL-... SL4-AP-...	SL4-PIB-D

Accessories

SL7 and SL4 Series

Mounting Brackets

SL7/4-FW



Mounting Brackets for Vertical Mounting, Plastic

Standard Pack	For Use With ...	Catalog Number
1	SL4-PIB-... SL7-CB-...	SL7/4-FW

SL7/4-FW-T



M20 Cable Gland for Vertical Mounting, Metal (Includes Mounting Bracket)

Standard Pack	For Use With ...	Catalog Number
1	SL4-PIB-T-... SL7-CB-T-...	SL7/4-FW-T

Incandescent Bulb Tool

SL7/4-BET



Tool for Replacing Incandescent Bulb

Standard Pack	For Use With ...	Catalog Number
1	SL7-L-... SL4-L-...	SL7/4-BET

Incandescent Bulbs

SL7 Series

SL7-L12



Incandescent Bulbs, Mounting: Ba15d

Lifespan (h)	Rated Operational Voltage (U _e V)	Power (Watts)	Standard Pack	For Use With ...	Catalog Number
3000	12	5	1	SL7-L-...	SL7-L12
	24	6.5			SL7-L24
	120	7			SL7-L120
	230	6.5			SL7-L230

SL4 Series

SL4-L12



Incandescent Bulbs, Mounting: Ba15d

Lifespan (h)	Rated Operational Voltage (U _e V)	Power (Watts)	Standard Pack	For Use With ...	Catalog Number
3000	12	4	1	SL4-L-...	SL4-L12
	24				SL4-L24
	120				SL4-L120
	230				SL4-L230

Technical Data and Specifications

2

SL7 Series

SL7 General Specifications

Description	Specification
Standards	IEC/EN 60947-5-1
Lens color	Blue, green, red, clear, yellow, amber
Number of signal elements	Max. 5 with standard base Max. 10 with base for mounting on both sides
Mechanical Ratings	
Shock (IEC 68-2-27)	11 ms, 15g
Vibration (IEC 68-2-6)	20 sweeps 10–150 Hz, 1g
Climate Conditions	
Climatic proofing	Damp heat, constant, to IEC 60068-2-78 Damp heat, cyclic, to IEC 60069-2-30
Operating temperature	–22° to +140°F (–30° to +60°C)
Storage temperature	–22° to +185°F (–30° to +85°C)
Environmental Ratings	
IEC degree of protection	UL Type 4/4X/13, IP66 IEC/EN 60529
Protection type UL	Type 4/4X/13
Materials	
Cover	Polycarbonate
Lenses	Polycarbonate
Stacklight base	Polycarbonate
Tubes	Aluminum
Terminal Capacity	
Solid or flexible conductor	0.13–2.5 mm ²
Flexible with ferrule with plastic collar	0.25–1.5 mm ² AWG 24–AWG 14
Contacts	
Rated impulse withstand voltage (U _{imp})	4000 Vac
Rated insulation voltage (U _i)	250V
Overvoltage category/pollution degree	III/3

SL7 Light Module Specifications

	Unit	SL7-L-...-...	SL7-BL-...-...	SL7-FL-...-...	SL7-L24-...-HP	SL7-FL24-...-HP	SL7-FL24-...-HPM	SL7-L-...
Type of light		Continuous light	Flashing light	Strobe light	Continuous light	Strobe light	Multi-strobe light	Continuous light
Light elements		LED	LED	LED	High-performance LED	High-performance LED	High-performance LED	Incandescent bulb (max. 7W)
Mounting		—	—	—	—	—	—	Ba15d
Flashing/strobe frequency		—	2 Hz	1.4 Hz	—	1.4 Hz	1–2.6 Hz	—
Transmission angle		360°	360°	360°	360°	360°	360°	360°
Leakage current	A	< 0.003	< 0.003	< 0.003	< 0.003	< 0.003	< 0.003	< 0.003
Current-/power consumption								
24 Vac/Vdc	A	0.049–0.054	0.058	0.130–0.135	0.170–0.200	0.260–0.265	0.260–0.265	—
110/120 Vac	A	0.028–0.031	0.028–0.030	0.010	—	—	—	—
230/240 Vac	A	0.027–0.028	0.030–0.031	0.010	—	—	—	—
Power consumption		—	—	—	—	—	—	Max. 7W with the specified voltages
Voltage levels		24 Vac/Vdc ± 10% 110/120 Vac ± 10% 230/240 Vac ± 10%	24 Vac/Vdc ± 10% 110/120 Vac ± 10% 230/240 Vac ± 10%	24 Vac/Vdc ± 10% 110/120 Vac ± 10% 230/240 Vac ± 10%	18–30 Vdc/ 18–26 Vac	18–30 Vdc/ 18–26 Vac	18–30 Vdc/ 18–26 Vac	Up to 250 Vac/Vdc
Lifespan	h	100,000	100,000	100,000	50,000	50,000	50,000	3000
Weight	g	80	80	80	80	80	80	80

SL7 Acoustic Module Specifications

	Unit	SL7-AP...	SL7-AP...-E	SL7-AP...-M
Type of tone		Continuous or pulsed tone	Continuous or pulsed tone	Continuous or pulsed tone Eight types of sound
Types of sound		Two versions, table of sound types	Two versions, table of sound types	Eight versions, table of sound types
Sound setting		Internal; single-pole DIP	Can be externally actuated	Internal; three-pole DIP
Sound pressure	dB	Max.: 100 Min.: 88	Max.: 100 Min.: 88	Max.: 100 Min.: 88
Sound pressure level adjustment		Built-in, potentiometer	Built-in, potentiometer	Built-in, potentiometer
Transmission angle		360°	360°	360°
Current-/power consumption				
24 Vac/Vdc	A	0.092	0.092	0.115
110/120 Vac	A	0.041	0.041	0.045
230/240 Vac	A	0.043	0.043	0.043
Voltage levels		24 Vac/Vdc ± 10% 110/120 Vac ± 10% 230/240 Vac ± 10%	24 Vac/Vdc ± 10% 110/120 Vac ± 10% 230/240 Vac ± 10%	24 Vac/Vdc ± 10% 110/120 Vac ± 10% 230/240 Vac ± 10%
Weight	g	102	102	102

SL7 Table of Sound Types

	Sound Type	Frequency (Hz)	Diagram	Repeat Rate	DIP Switch Position	Maximum Volume at 1M (dB)
SL7-AP...	Continuous tone	Approx. 2800		—	—	100
	Pulsed tone	Approx. 2800		Approx. 2 Hz	—	100
SL7-AP...-E	Continuous tone	Approx. 2800		—	—	100
	Pulsed tone	Approx. 2800		Approx. 2 Hz	—	100
SL7-AP...-M	Continuous tone	2700		—	ON	Tone 01 100
	Continuous tone	1350		—	ON	Tone 02 100
	Pulsed tone	2700		250 ms on, 250 ms off	ON	Tone 03 100
	Pulsed tone	1350		250 ms on, 250 ms off	ON	Tone 04 100
	Falling	1200–500		1 Hz	ON	Tone 05 98
	Rising	500–1200		Rising 3s, 0.5s off	ON	Tone 06 98
	Alternating	800–1000		2 Hz	ON	Tone 07 94
	rising/falling	500–1500		10 Hz	ON	Tone 08 94

SL4 Series**SL4 General Specifications**

Description	Specification
Standards	IEC/EN 60947-5-1
Lens color	Blue, green, red, clear, yellow, orange
Number of signal elements	Max. 5 with standard base Max. 10 with base for mounting on both sides
Mounting position	As required
Mechanical Ratings	
Mechanical shock resistance	>15g according to IEC 60068-2-27 Shock duration 11 ms Sinusoidal
Climate Conditions	
Climatic proofing	Damp heat, constant, to IEC 60068-2-78 Damp heat, cyclic, to IEC 60069-2-30
Ambient temperature	-22°F to +140°F (-30°C to +60°C)
Environmental Ratings	
IEC degree of protection	UL Type 4/4X/13, IP66 IEC/EN 60529
Protection type UL	Type 4/4X/13
Materials	
Enclosure	Polycarbonate (PC), black
Cap	Polycarbonate (PC)
Terminal Capacity	
Solid or flexible conductor	0.2–1.5 mm ²
Solid or flexible conductor, with ferrule	0.25–1.5 mm ²
Flexible with ferrule with plastic collar	0.25–0.75 mm ² AWG 24–AWG 16
Contacts	
Rated impulse withstand voltage (U _{imp})	4000 Vac
Rated insulation voltage (U _i)	250V
Overvoltage category/pollution degree	III/3

SL4 Light Module Specifications

	Unit	SL4-L...-...	SL4-BL...-...	SL4-FL...-...	SL4-FL24...-M	SL4-L...
Type of light		Continuous light	Flashing light	Strobe light	Multi-strobe light	Continuous light
Light elements		LED	LED	LED	LED	Incandescent bulb (max. 4W)
Mounting		—	—	—	—	Ba15d
Flashing/strobe frequency		—	2 Hz	1.4 Hz	1–2.6 Hz	—
Transmission angle		360°	360°	360°	360°	360°
Leakage current	A	< 0.003	< 0.003	< 0.003	< 0.003	< 0.003
Current/power consumption						
24 Vac/Vdc	A	0.022–0.033	0.028–0.036	0.035–0.065	0.048–0.068	—
110/120 Vac	A	0.030	0.030	0.10	—	—
230/240 Vac	A	0.030	0.030	0.10	—	—
Power consumption		—	—	—	—	Maximum 4W with the specified voltages
Voltage levels		24 Vac/Vdc ± 10% 110/120 Vac ± 10% 230/240 Vac ± 10%	24 Vac/Vdc ± 10% 110/120 Vac ± 10% 230/240 Vac ± 10%	24 Vac/Vdc ± 10% 110/120 Vac ± 10% 230/240 Vac ± 10%	24 Vac/Vdc ± 10%	Up to 250 Vac/Vdc
Lifespan	h	100,000	100,000	100,000	100,000	100,000
Weight	g	45	45	45	45	45

SL4 Acoustic Module Specifications

	Unit	SL4-AP...
Type of tone		Continuous or pulsed tone
Types of sound		Two versions, table of sound types
Sound setting		Internal; single-pole DIP
Sound pressure	dB	80
Sound pressure level adjustment		—
Sound pressure can be lowered to a minimum of		—
Transmission angle		360°
Current/power consumption		
24 Vac/Vdc	A	0.039
110/120 Vac	A	0.021
230/240 Vac	A	0.021
Voltage levels		24 Vac/Vdc ± 10% 110/120 Vac ± 10% 230/240 Vac ± 10%
Weight	g	43

SL4 Table of Sound Types

	Sound Type	Frequency (Hz)	Diagram	Repeat Rate	Maximum Volume at 1M (dB)
SL4-AP...	Continuous tone	Approx. 4000	————	—	80
	Pulsed tone	Approx. 4000	— — —	Approx. 2 Hz	80

Dimensions

Approximate Dimensions in Inches (mm)

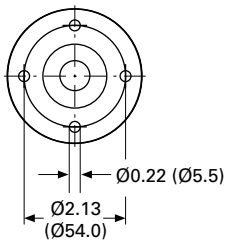
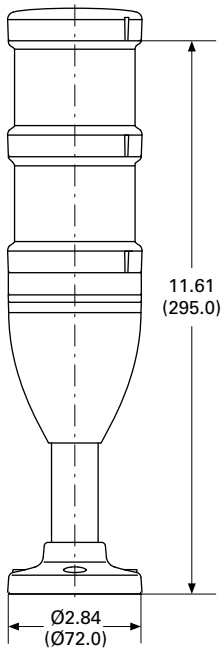
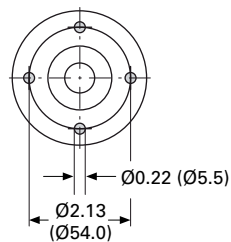
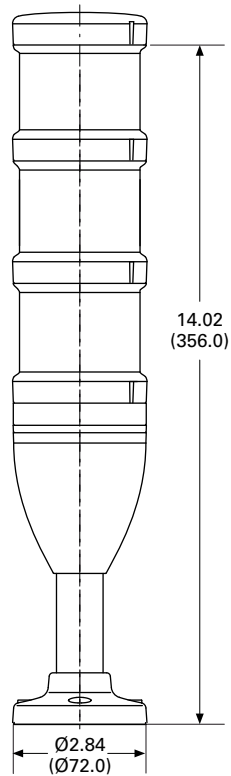
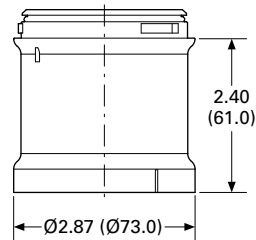
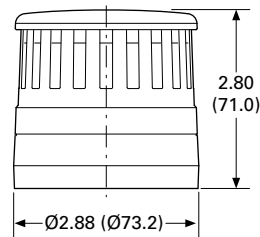
SL7 Series**Complete Devices****SL7-100-L-RG-24LED****SL7-100-L-RYG-24LED****Light Modules****SL7-(B)(F)L...****Acoustic Modules****SL7-AP...**

2.1

Stacklights

SL Series

Approximate Dimensions in Inches (mm)

2

Basic Modules

SL7-CB-...

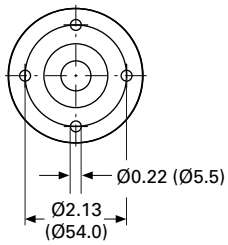
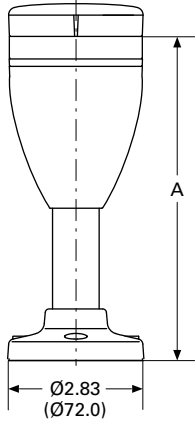

Catalog Number	A
SL7-CB-100	6.73 (171.0)
SL7-CB-250	12.64 (321.0)
SL7-CB-400	18.54 (471.0)

SL7-CB-T...

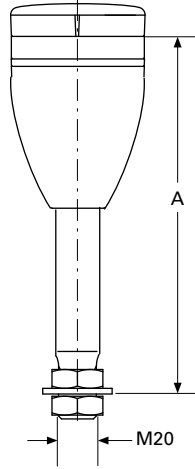

Catalog Number	A
SL7-CB-T-100	7.48 (190.0)
SL7-CB-T-250	13.38 (340.0)
SL7-CB-T-400	19.29 (490.0)

SL7-CB-D

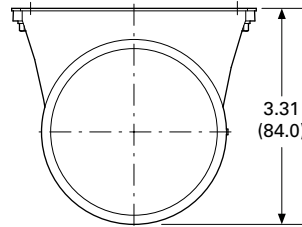
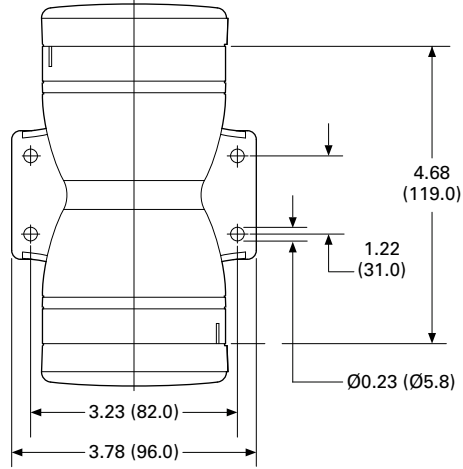

SL7-CB-EMH

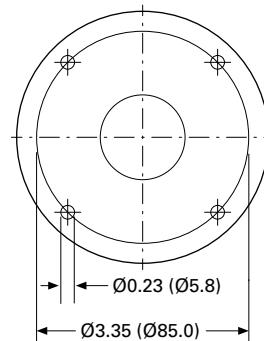
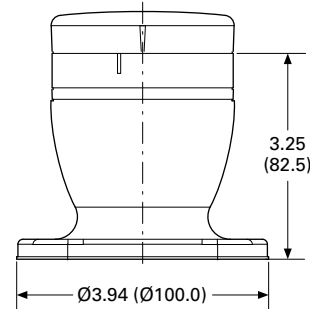

Approximate Dimensions in Inches (mm)

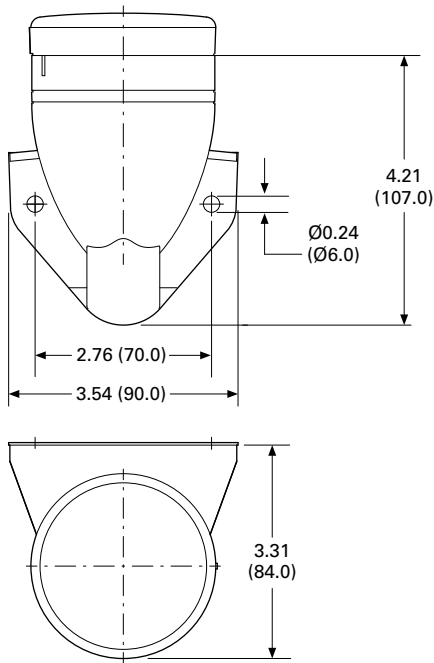
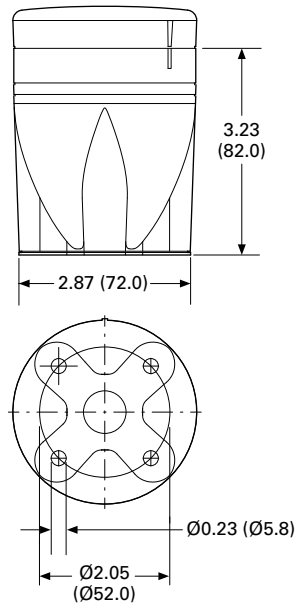
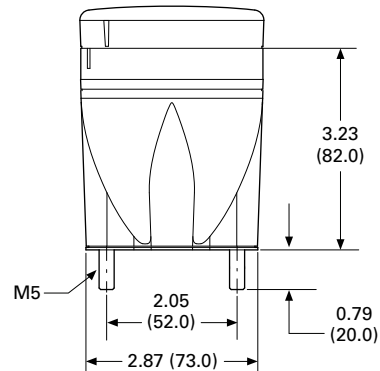
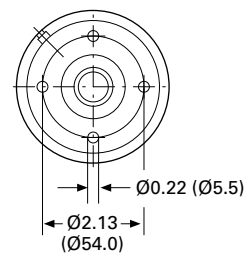
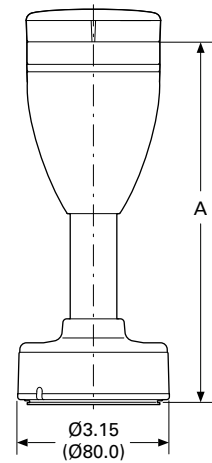
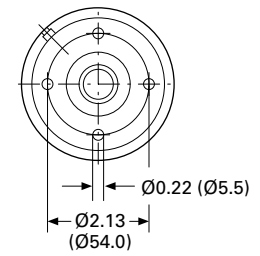
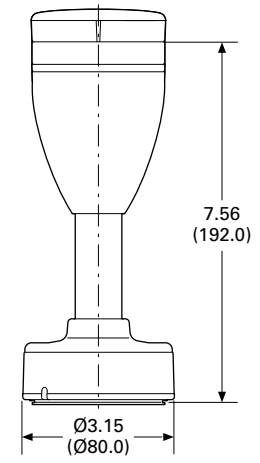
SL7-CB-FW**SL7-CB-IMH****SL7-CB-IMS****SL7-FMS-...****SL7-SWD ①**

Catalog Number	A
SL7-FMS-100	7.55 (192.0)
SL7-FMS-250	13.46 (342.0)
SL7-FMS-400	19.37 (192.0)

Note

① For connecting to SmartWire-DT.

2.1

Stacklights

SL Series

Approximate Dimensions in Inches (mm)

2

SL4 Series

Complete Devices

SL4-100-L-RG-24LED

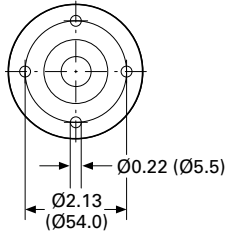
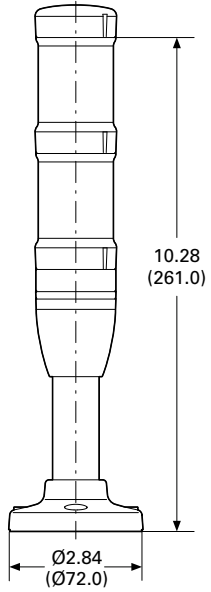

SL4-100-L-RYG-24LED

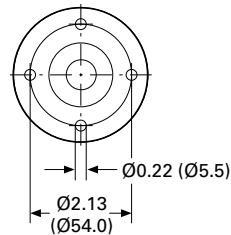
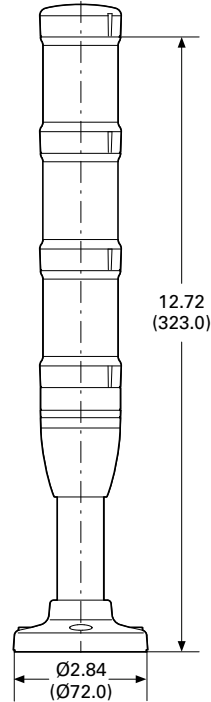

Light Modules

SL4-(B)(F)L...

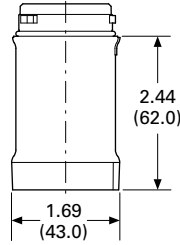

Acoustic Modules

SL4-AP...

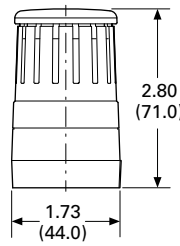

Approximate Dimensions in Inches (mm)

Basic Modules

SL4-PIB-...

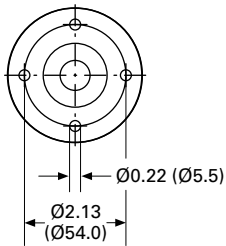
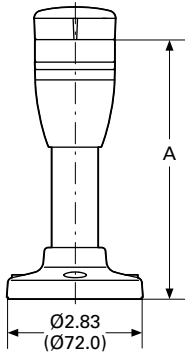

Catalog Number	A
SL4-PIB-100	3.53 (136.0)
SL4-PIB-250	11.26 (286.0)
SL4-PIB-400	17.16 (436.0)

SL4-PIB-T...

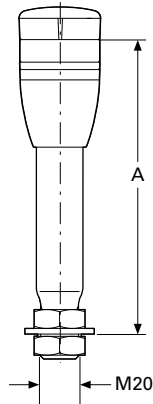

Catalog Number	A
SL4-PIB-T-100	5.90 (150.0)
SL4-PIB-T-250	11.81 (300.0)
SL4-PIB-T-400	17.72 (450.0)

SL4-PIB-D

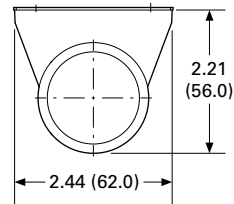
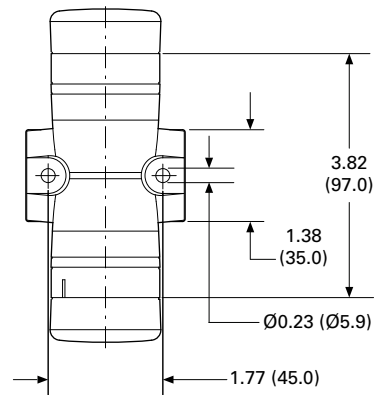

SL4-PIB-EMH

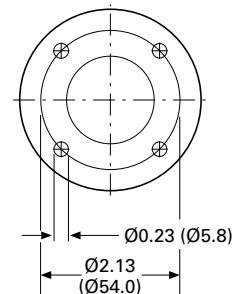
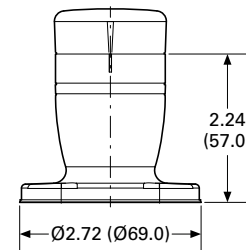

2.1

Stacklights

SL Series

Approximate Dimensions in Inches (mm)

2

SL4-PIB-FW

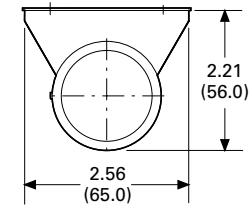
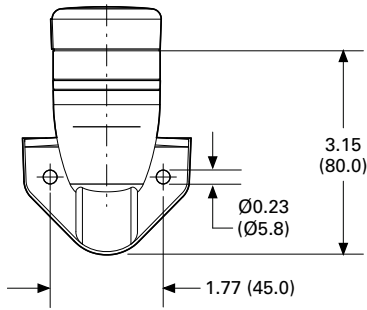

SL4-PIB-IMH

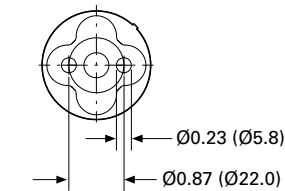
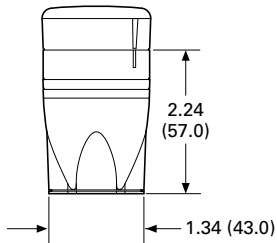

SL4-PIB-IMS

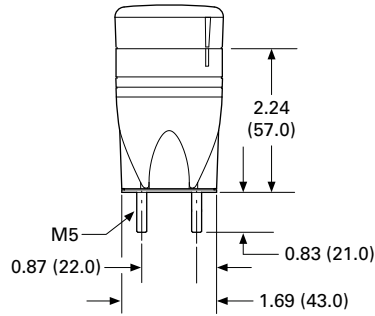

SL4-FMS-...

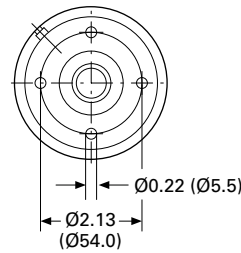
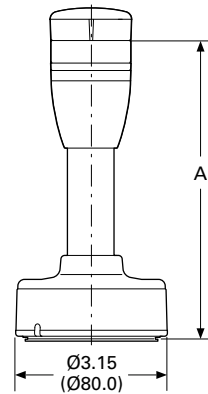

SL4-SWD^①

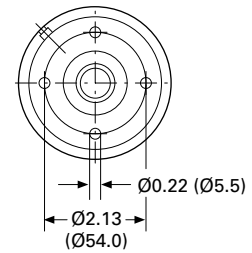
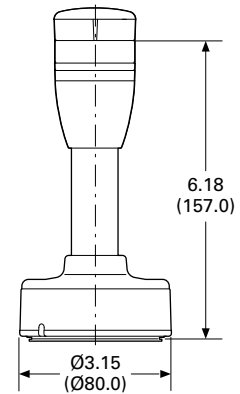

Catalog Number	A
SL4-FMS-100	6.18 (157.0)
SL4-FMS-250	12.09 (307.0)
SL4-FMS-400	17.99 (457.0)

Note

① For connecting to SmartWire-DT.

Approximate Dimensions in Inches (mm)

Mounting Brackets

SL7/4-FW

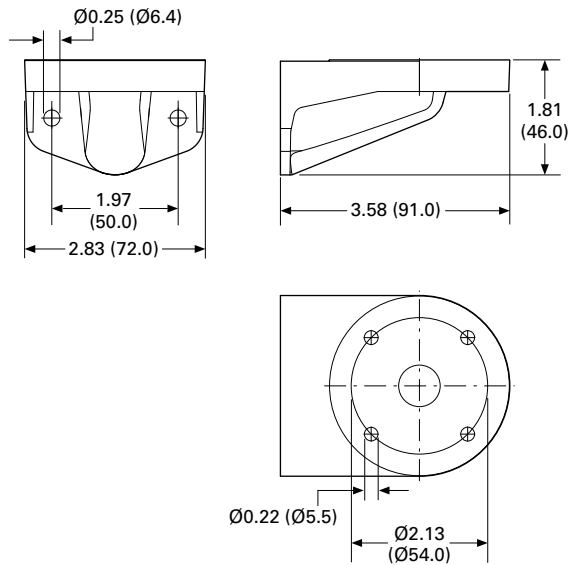

SL7/4-FW-T

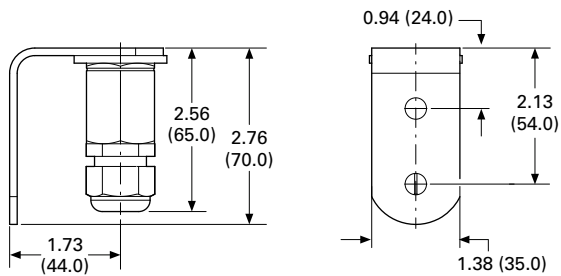

Incandescent Bulbs

SL7-L12 and SL4-L12

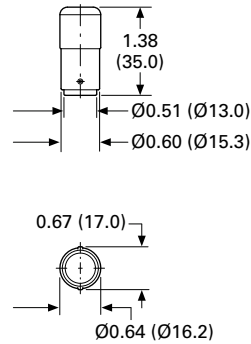

Tool for Replacing Incandescent Bulb

SL7/4-BET

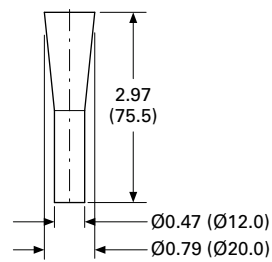

Stacklights—E26 Series

2



Product Description

The E26 stacklight unit is a modular system that provides illuminated and audible status indication in all directions. Easily assembled plug-in modular units include constant, flashing and strobe light units, as well as mono-tonal, bi-tonal, intermittent audible alarms. Stacklights may be assembled in a variety of configurations, which are identified in the Maximum Configurations table on **Page V7-T2-33**. Several lamp, color and mounting options further enhance the stacklight's versatility.

Features

- Modular construction
- Six lens colors
- Variety of lamp types and voltages
- Mono-tonal, bi-tonal and intermittent audible alarms

Benefits

- Combination of visible and audible alarms
- Modular components reduce inventory requirements, increase flexibility
- Steady and flashing modes allow one light to signal multiple conditions
- No-tools assembly permits easy lamp replacement

Standards and Certifications

- CE 60947-5-1
- UL 508—File No. E131568
- cUL C22.2 No. 14—File No. E131568



Ingress Protection

- Stacklight base and light units: IP65, NEMA 4, 4X and 13
- Alarm units: IP20, NEMA 1

Electrical Shock Protection

- Stacklight base and light unit: IP2X
- Alarm units: IPOX

Contents

<i>Description</i>	<i>Page</i>
E26 Series	
Product Identification	V7-T2-33
Catalog Number Selection	V7-T2-34
Product Selection	V7-T2-35
Replacement Parts	V7-T2-40
Technical Data and Specifications	V7-T2-41
Ratings	V7-T2-42
Mounting Instructions	V7-T2-43
Dimensions	V7-T2-44

Product Identification



Standard Stacklight Base

For use with incandescent or standard LEDs for steady, non-flashing illumination or with flashing LEDs for flashing illumination. Bases include terminal block for wiring, stacklight cover and gasket. See **Page V7-T2-38**.



Flashing Stacklight Base

Allows configuration of each light in the stack for either steady or 60 times per minute flashing illumination. Flashing circuit for use with incandescent lamps only. (Maximum allowable number of light modules is 2 at 12V, 4 at 24V and 6 at 48V and above.) See **Page V7-T2-38**.

For flashing LEDs use standard base with flashing LED light module.



Light Modules

Available in a variety of colors for both incandescent lamps and LED lamps. To maximize illumination and light dispersion, incandescent units include an opal white diffuser while LED diffusers are clear. See **Page V7-T2-36**.



Xenon Strobe

Sets are similar to standard lens/diffuser units, except each set consists of two lens units. The lower unit includes the electronics and is permanently fused to the upper unit which contains the Xenon lamp. Xenon units may be placed in any position in a complete stacklight unit. They will flash 60 times per minute when used with a standard or flashing base. See **Page V7-T2-36**.



Alarms

May be fitted to the top of a complete stacklight unit or directly to the stacklight bases, if desired. Available in three versions, each with adjustable sound levels. See **Page V7-T2-39**.

Complete Stacklight Modules



- Stacklights accept a maximum of six incandescent or LED light modules or two Xenon Flasher modules and can be mounted in any position on the stack.
- Alarm units are mounted in the top most position only.

Maximum Configurations

Incandescent or LED Modules	Xenon Modules	Alarm Modules	Max. Number of Modules
6	—	—	6
5	—	1	6
4	1	—	5
3	1	1	5
2	2	—	4
1	2	1	4

Catalog Number Selection

Stacklight Catalog Numbering System

2

E26X 9 KM L 39R W - V 4

Mounting Base ^①		
Code	Description	Component Catalog No.
W	None (base mount)	—
4	3/4 in NPT hub, chrome	E26S104
8	Standard three-hole	E26S108
9	Standard four-hole	E26S109

Extension Tube ^⑤		
Code	Description	Component Catalog No.
W	None (base mount)	—
Gray Aluminum		
HM	20 mm 3/4 in NPT	E26BHM
JM	160 mm 3/4 in NPT	E26BJM
KM	360 mm 3/4 in NPT	E26BKM
MM	760 mm 3/4 in NPT	E26BMM
Black Aluminum		
HU	20 mm 3/4 in NPT	E26BHU
JU	160 mm 3/4 in NPT	E26BJU
KU	360 mm 3/4 in NPT	E26BKU
MU	760 mm 3/4 in NPT	E26BMU
RU	Right angle 3/4 in NPT	E26BRU

Stacklight Base		
Code	Description	Component Catalog No. ^②
L	Standard	E26BL
F	Flashing ^⑥	E26BF_

Alarm		
Code	Description	Component Catalog No. ^②
W	None	—
Q	Mono-tonal	E26BQ_
N	Bi-tonal	E26BN_
P	Intermittent	E26BP_

Voltage ^③	
Code	Description
V1	12V
V2	24V
V3	48V
V4	120V
V5 ^④	240V

Light Module		
Code	Description	Component Catalog No. ^②
0	Clear incandescent	E26B0_
2	Red incandescent	E26B2_
3	Green incandescent	E26B3_
4	Yellow incandescent	E26B4_
6	Blue incandescent	E26B6_
9	Amber incandescent	E26B9_
W	White cluster LED with clear lens	E26BW_
R	Red cluster LED with red lens	E26BR_
G	Green cluster LED with green lens	E26BG_
Y	Yellow cluster LED with yellow lens	E26BY_
B	Blue cluster LED with blue lens	E26BB_
A	Amber cluster LED with amber lens	E26BA_
W1	White cylindrical LED with clear lens ^④	E26BW1_
R1	Red cylindrical LED with red lens ^④	E26BR1_
G1	Green cylindrical LED with green lens ^④	E26BG1_
Y1	Yellow cylindrical LED with yellow lens ^④	E26BY1_
B1	Blue cylindrical LED with blue lens ^④	E26BB1_
A1	Amber cylindrical LED with amber lens ^④	E26BA1_
M	Flashing white cluster LED with clear lens	E26BM_
E	Flashing red cluster LED with red lens	E26BE_
U	Flashing green cluster LED with green lens	E26BU_
V	Flashing yellow cluster LED with yellow lens	E26BV_
K	Flashing blue cluster LED with blue lens	E26BK_
Z	Flashing amber cluster LED with amber lens	E26BZ_
X0	Xenon flasher with clear lens	E26BX0_
X2	Xenon flasher with red lens	E26BX2_
X3	Xenon flasher with green lens	E26BX3_
X4	Xenon flasher with yellow lens	E26BX4_
X6	Xenon flasher with blue lens	E26BX6_
X9	Xenon flasher with amber lens	E26BX9_

Voltage Codes

Voltage Code	Incandescent Lamp	Cluster LED	Cylindrical LED	Xenon Flasher	Flasher Base/Alarm
(Blank)	No lamp supplied	No LED supplied	No LED supplied	—	—
V1	12 Vac/Vdc	12 Vac/Vdc	12 Vac/Vdc	12 Vac/Vdc	12 Vac/Vdc
V2	24 Vac/Vdc	24 Vac/Vdc	24 Vac/Vdc	24 Vac/Vdc	24 Vac/Vdc
V3	48 Vac/Vdc	48 Vac/Vdc	48 Vac/Vdc	48 Vac/Vdc	48 Vac/Vdc
V4	120 Vac/Vdc	120 Vac	120 Vac	120 Vac	120 Vac/Vdc
V5	240 Vac/Vdc	240 Vac	—	240 Vac	240 Vac/Vdc

Notes

- ① Unless base mount is specified, an extension tube must be selected for a complete unit.
- ② Component catalog numbers for flashing bases, alarm units and light modules are incomplete and require the addition of a suffix code to specify the required voltage rating. See table above.
- ③ If no voltage is specified, assembled stacklight will be supplied without lamps or LEDs.
- ④ 240V not available for cylindrical LEDs.
- ⑤ For complete length (extension tube and base), see **Page V7-T2-39**.
- ⑥ Flashing base is for use with incandescent lamps.

Product Selection

Assembled Units

One-, Two- and Three-Light Assembled Stacklights

- Base mountable
- Incandescent or LED versions
- 24V and 120V versions

One-Light Unit Stacklight

Volts AC/DC	Alarm	First Level Color	Illumination Type	Catalog Number
24V	None	Red	Incandescent—steady	E26XWWL2W-V2
24V	None	Red	Cylindrical LED—steady	E26XWWLR1W-V2
24V	None	Green	Incandescent—steady	E26XWWL3W-V2
24V	None	Green	Cylindrical LED—steady	E26XWWLG1W-V2
24V	None	Amber	Incandescent—steady	E26XWWL9W-V2
24V	None	Amber	Cylindrical LED—steady	E26XWWLA1W-V2
120V	None	Red	Incandescent—steady	E26XWWL2W-V4
120V ^①	None	Red	Cylindrical LED—steady	E26XWWLR1W-V4
120V	None	Green	Incandescent—steady	E26XWWL3W-V4
120V ^①	None	Green	Cylindrical LED—steady	E26XWWLG1W-V4
120V	None	Amber	Incandescent—steady	E26XWWL9W-V4
120V ^①	None	Amber	Cylindrical LED—steady	E26XWWLA1W-V4

Two-Light Unit Stacklight

Volts AC/DC	Alarm	First Level Color	Illumination Type	Second Level Color	Illumination Type	Catalog Number
24V	None	Green	Incandescent—steady	Red	Incandescent—steady	E26XWWL32W-V2
24V	None	Green	Cylindrical LED—steady	Red	Cylindrical LED—steady	E26XWWLG1R1W-V2
120V	None	Green	Incandescent—steady	Red	Incandescent—steady	E26XWWL32W-V4
120V ^①	None	Green	Cylindrical LED—steady	Red	Cylindrical LED—steady	E26XWWLG1R1W-V4

Three-Light Unit Stacklight

Volts AC/DC	Alarm	First Level Color	Illumination Type	Second Level Color	Illumination Type	Third Level Color	Illumination Type	Catalog Number
24V	None	Green	Incandescent—steady	Amber	Incandescent—steady	Red	Incandescent—steady	E26XWWL392W-V2
24V	None	Green	Cylindrical LED—steady	Amber	Cylindrical LED—steady	Red	Cylindrical LED—steady	E26XWWLG1A1R1W-V2
120V	None	Green	Incandescent—steady	Amber	Incandescent—steady	Red	Incandescent—steady	E26XWWL392W-V4
120V ^①	None	Green	Cylindrical LED—steady	Amber	Cylindrical LED—steady	Red	Cylindrical LED—steady	E26XWWLG1A1R1W-V4

Note

- ^① LED modules have very low current draw and should not be used with triac output devices like PLC triac output modules. It is recommended that dry contact outputs be used to switch 120 Vac modules.

Light and Xenon Strobe Modules

- Light modules include lens diffusers which provide even illumination and eliminate hot spots.
- Xenon strobes emit a bright attention-getting white flashing light. Flash rate = 60/min.
- Xenon strobe modules occupy two positions in the stacklight assembly.

Light/LED Module



Xenon Strobe Module



Light and Xenon Strobe Modules ^①

LED/Lamp Voltage	Lens Color	Incandescent Steady or Flashing Catalog Number	Cylindrical LED Steady Only Catalog Number	Cluster LED Steady Catalog Number	Cluster LED Flashing Catalog Number	Xenon Flashing Catalog Number
Without bulb or LED	Red	E26B2	E26B	E26BR	E26BR	—
	Green	E26B3	E26BG	E26BG	E26BG	—
	Yellow	E26B4	E26BY	E26BY	E26BY	—
	Blue	E26B6	E26BB	E26BB	E26BB	—
	Amber	E26B9	E26BA	E26BA	E26BA	—
	Clear	E26B0	E26BW	E26BW	E26BW	—
12 Vac/Vdc	Red	E26B2V1	E26BR1V1	E26BRV1	E26BEV1	E26BX2V1
	Green	E26B3V1	E26BG1V1	E26BGV1	E26BUV1	E26BX3V1
	Yellow	E26B4V1	E26BY1V1	E26BYV1	E26BVV1	E26BX4V1
	Blue	E26B6V1	E26BB1V1	E26BBV1	E26BKV1	E26BX6V1
	Amber	E26B9V1	E26BA1V1	E26BAV1	E26BZV1	E26BX9V1
	Clear	E26B0V1	E26BW1V1	E26BWW1	E26BMV1	E26BX0V1
24 Vac/Vdc	Red	E26B2V2	E26BR1V2	E26BRV2	E26BEV2	E26BX2V2
	Green	E26B3V2	E26BG1V2	E26BGV2	E26BUV2	E26BX3V2
	Yellow	E26B4V2	E26BY1V2	E26BYV2	E26BVV2	E26BX4V2
	Blue	E26B6V2	E26BB1V2	E26BBV2	E26BKV2	E26BX6V2
	Amber	E26B9V2	E26BA1V2	E26BAV2	E26BZV2	E26BX9V2
	Clear	E26B0V2	E26BW1V2	E26BWW2	E26BMV2	E26BX0V2
48 Vac/Vdc	Red	E26B2V3	E26BR1V3	E26BRV3	E26BEV3	E26BX2V3
	Green	E26B3V3	E26BG1V3	E26BGV3	E26BUV3	E26BX3V3
	Yellow	E26B4V3	E26BY1V3	E26BYV3	E26BVV3	E26BX4V3
	Blue	E26B6V3	E26BB1V3	E26BBV3	E26BKV3	E26BX6V3
	Amber	E26B9V3	E26BA1V3	E26BAV3	E26BZV3	E26BX9V3
	Clear	E26B0V3	E26BW1V3	E26BWW3	E26BMV3	E26BX0V3
120 Vac ^②	Red	E26B2V4	E26BR1V4	E26BRV4	E26BEV4	E26BX2V4
	Green	E26B3V4	E26BG1V4	E26BGV4	E26BUV4	E26BX3V4
	Yellow	E26B4V4	E26BY1V4	E26BYV4	E26BVV4	E26BX4V4
	Blue	E26B6V4	E26BB1V4	E26BBV4	E26BKV4	E26BX6V4
	Amber	E26B9V4	E26BA1V4	E26BAV4	E26BZV4	E26BX9V4
	Clear	E26B0V4	E26BW1V4	E26BWW4	E26BMV4	E26BX0V4
240 Vac ^②	Red	E26B2V5	—	E26BRV5	E26BEV5	E26BX2V5
	Green	E26B3V5	—	E26BGV5	E26BUV5	E26BX3V5
	Yellow	E26B4V5	—	E26BYV5	E26BVV5	E26BX4V5
	Blue	E26B6V5	—	E26BBV5	E26BKV5	E26BX6V5
	Amber	E26B9V5	—	E26BAV5	E26BZV5	E26BX9V5
	Clear	E26B0V5	—	E26BWW5	E26BMV5	E26BX0V5

Notes

- ① Include lens, diffusers and lamps unless otherwise noted.
- ② Incandescent bulbs are AC/DC rated, LEDs are AC rated only.

LEDs—Cylindrical or Cluster

Cylindrical
Stacklight LED

Cluster LED



Cylindrical or Cluster LEDs

Voltage	Color	Cylindrical LED	Cluster LED	Cluster LED
		Steady Only Catalog Number	Steady Catalog Number	Flashing Catalog Number
12 Vac/Vdc	Red	E26S110	E26S15	E26S48
	Green	E26S114	E26S19	E26S53
	Yellow	E26S112	E26S23	E26S58
	Blue	E26S115	E26S27	E26S63
	White	E26S116	E26S71	E26S75
	Amber	E26S111	E26S79	E26S84
	24 Vac/Vdc	Red	E26S117	E26S16
Green		E26S121	E26S20	E26S54
Yellow		E26S119	E26S24	E26S59
Blue		E26S122	E26S28	E26S64
White		E26S123	E26S72	E26S76
Amber		E26S118	E26S80	E26S85
48 Vac/Vdc		Red	E26S124	E26S17
	Green	E26S128	E26S21	E26S55
	Yellow	E26S126	E26S25	E26S60
	Blue	E26S129	E26S29	E26S65
	White	E26S130	E26S73	E26S77
	Amber	E26S125	E26S81	E26S86
	120 Vac/Vdc	Red	E26S138	E26S18
Green		E26S142	E26S22	E26S56
Yellow		E26S140	E26S26	E26S61
Blue		E26S143	E26S30	E26S66
White		—	E26S74	E26S78
Amber		E26S139	E26S82	E26S87
240 Vac/Vdc		Red	—	E26S44
	Green	—	E26S45	E26S57
	Yellow	—	E26S46	E26S62
	Blue	—	E26S47	E26S67
	White	—	E26S101	E26S102
	Amber	—	E26S83	E26S88

Mounting Bases Components

Standard Base

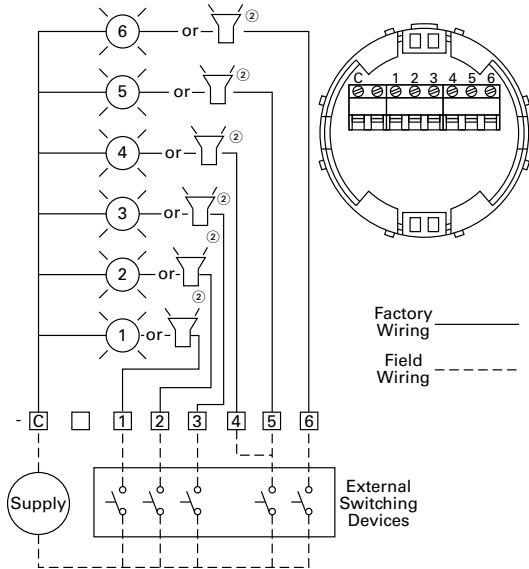

Flashing Base

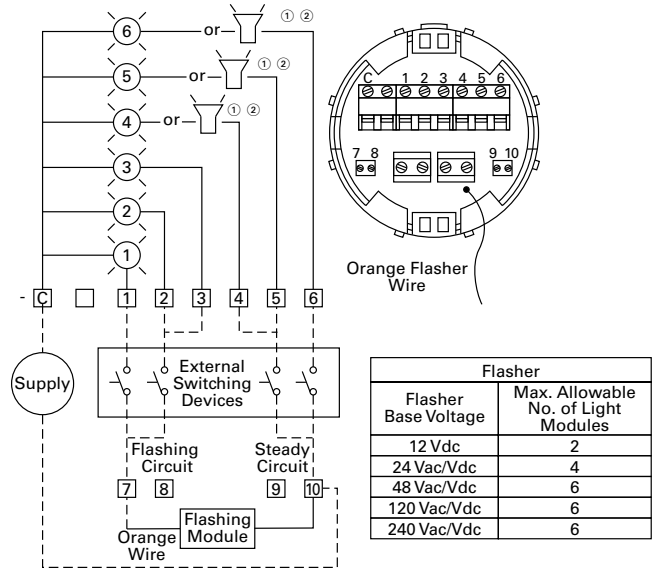

Description	Voltage	Catalog Number
Standard Base		
For use with steady incandescent or steady/flashing LED	12 Vac/Vdc to 240 Vac/Vdc	E26BL
Flashing Base		
Enables configuration of incandescent light modules for steady or flashing operation	12 Vdc	E26BFV1
	24 Vac/Vdc	E26BFV2
	48 Vac/Vdc	E26BFV3
	120 Vac/Vdc	E26BFV4
	240 Vac/Vdc	E26BFV5

Mounting Bases and Hubs

Description	Voltage	Catalog Number
Standard Three-Hole Mounting Base		
Standard three-hole mounting base	—	E26S108
Standard Four-Hole Mounting Base		
Standard four-hole mounting base	—	E26S109
Myers Type Hub		
3/4 in NPT threaded hub	—	E26S104

Notes

- ① Audible alarm units must be wired via the steady circuit on flashing base units.
- ② Audible alarm units can be wired in positions as shown but only one unit is permitted on each stack and unit must occupy the last or top mounting position.

Alarm Units and Extension Tubes Components

E26B_



Audible Alarm Units-NEMA Type 1 (IP20) ①

Description	Voltage	Catalog Number
Mono-Tonal		
4.5 mA	12 Vac/Vdc	E26BQV1
12.6 mA	24 Vac/Vdc	E26BQV2
9.4 mA	48 Vac/Vdc	E26BQV3
11.5 mA	120 Vac/Vdc	E26BQV4
5.1 mA	240 Vac/Vdc	E26BQV5
Bi-Tonal		
4.5 mA	12 Vac/Vdc	E26BNV1
12.6 mA	24 Vac/Vdc	E26BNV2
9.4 mA	48 Vac/Vdc	E26BNV3
11.5 mA	120 Vac/Vdc	E26BNV4
5.1 mA	240 Vac/Vdc	E26BNV5
Intermittent		
4.5 mA	12 Vac/Vdc	E26BPV1
12.6 mA	24 Vac/Vdc	E26BPV2
9.4 mA	48 Vac/Vdc	E26BPV3
11.5 mA	120 Vac/Vdc	E26BPV4
5.1 mA	240 Vac/Vdc	E26BPV5

Extension Tubes

Extension Tube

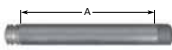

Description	Voltage	Catalog Number
Extension "A" ②		
0.79 in (20 mm) extension	—	E26BHM
6.30 in (160 mm) extension	—	E26BJM
14.17 in (360 mm) extension	—	E26BKM
29.92 in (760 mm) extension	—	E26BMM

Extension Tube

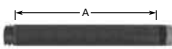

Extension "A" ③		
0.79 in (20 mm) extension	—	E26BHU
6.30 in (160 mm) extension	—	E26BJU
14.17 in (360 mm) extension	—	E26BKU
29.92 in (760 mm) extension	—	E26BMU

E26BRU



Right angle extension tube	—	E26BRU
----------------------------	---	---------------

Notes

- ① Volume adjustment range: 64 dB to 90 dB typical current draw (mA).
 ② For use with standard mounting base or 3/4 in NPT threaded hub—gray aluminum.
 ③ For use with standard mounting base or 3/4 in NPT threaded hub—black aluminum.

Replacement Parts

2

Stacklight Replacement Parts

Description	Notes	Number in Diagram	Catalog Number
Replacement cover	Normally included with stacklight base	1	E26S68
Replacement lens O-ring	Normally included with light modules	2	E26S106 ^①
Replacement lenses	Clear	3	E26S38
	Red		E26S39
	Green		E26S40
	Yellow		E26S41
	Blue		E26S42
	Amber		E26S43
Replacement Xenon strobe dual high (does not include lenses)	12 Vac/Vdc	4	E26S33
	24 Vac/Vdc		E26S34
	48 Vac/Vdc		E26S35
	120 Vac		E26S36
	240 Vac		E26S37
Replacement diffusers	White — normally supplied with incandescent light modules	4	E26S31
	Clear — normally supplied with LED light modules		E26S32
Replacement lamps ^②	12V	5	E26S8
	24V		E26S9
	48V		E26S10
	120V		E26S11
	240V		E26S12
Replacement extension tube O-rings	Normally included with extension tubes	6	E26S107 ^③
Replacement mounting gasket ^④	Normally included with stacklight base	7	E26S105
Lamp removal tool	For E26 and E22 incandescent lamps		E22BA3

Typical Stacklight Assemblies

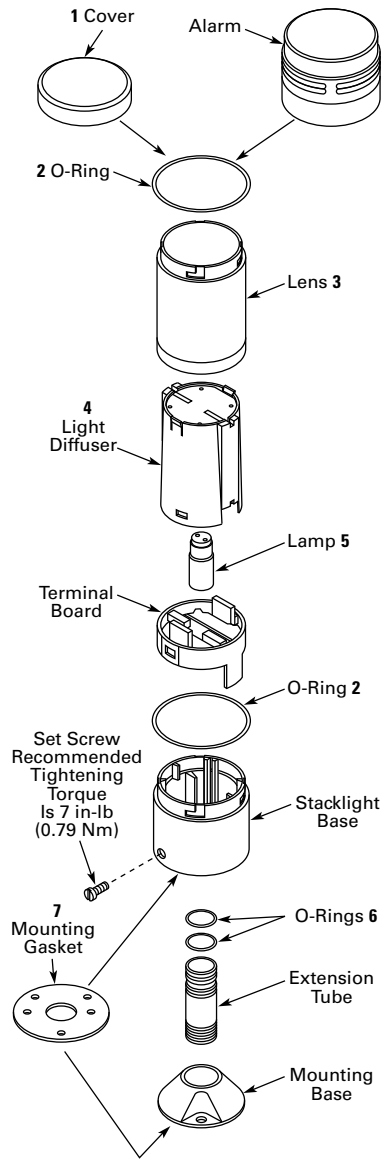

Typical Stacklight Assembly (Exploded View)

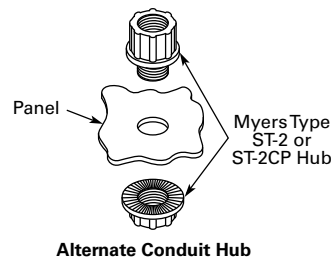

Notes

- ① Sold in packages of 5 pieces.
- ② For replacement LEDs, see table on **Page V7-T2-37**.
- ③ Sold in packages of 10 pieces.
- ④ Mounting gaskets have two sets of mounting holes—one set with center-to-center spacing of 1.75 in (44.5 mm) and another set with center-to-center spacing of 1.65 in (42 mm).

Technical Data and Specifications

General Specifications

Description	Specification
Mechanical Ratings	
Shock (IEC 68-2-27)	11 ms, 15g
Vibration (IEC 68-2-6)	10 sweeps 10–150 Hz, 2g
Bump (IEC 68-2-29)	1000 pulses, 6 ms, 15g
Climate Conditions	
Operating	Maximum 104°F (40°C) at 95% RH, Temperature –4° to 140°F (–20° to 60°C)
Storage	Temperature –40° to 176°F (–40° to 80°C)
Materials	
Cover	Polycarbonate
Lenses	Polycarbonate
Stacklight base	Nylon
Extension tubes	Aluminum
Mounting base	Zinc die cast
Terminals	
Single conductor	14–30 AWG (2.5–0.05 mm ²)
Two conductors (same size)	18–26 AWG (0.75–0.14 mm ²) Do not mix solid and stranded wire in the same terminal
Recommended tightening torque	4.4–5.3 lb-in (0.5–0.6 Nm)
Electrical Ratings	
Insulation voltage (U _i)	690V
Operational voltage (U _e)	250V
Impulse withstand voltage (U _{imp})	1.5 kV
Bulb Specifications	
Incandescent lamp type	BA15d
Maximum lamp wattage	6W
Bulbs—average life	
Incandescent	7,000 to 12,000 hrs. (based on voltage)
Xenon flasher	20,000 hrs.
LED	60,000 to 100,000 hrs. (based on colors)
LED/Incandescent Comparison	
Incandescent lamps	Average operating life of 7,000 hours Each lamp can be used with any color lens Low cost results in short term savings
LED lamps	Average operating life of 60,000 to 100,000 hours Low power consumption Extended life results in long-term savings

Ratings

Published theoretical lamp lives are based on ideal laboratory conditions and should be used for comparison only. Actual life may be shorter due to various application conditions.

2

Stacklight Incandescent Application Data

Type of Light	Lamp Used	Approximate Current, mA per Light	Theoretical Lamp Life, Hours as Applied
12V	BA15d	417	7,000
24V	BA15d	208	7,000
48V	BA15d	104	7,000
110–140V	BA15d	36–50	7,000
220–260V	BA15d	23–27	12,000

Xenon Flasher Application Data

Type of Light	Lamp Used	Approximate Current, mA per Light	Theoretical Lamp Life, Hours as Applied
12V	DC	460 mA	20,000
	AC	780 mA	20,000
24V	DC	190 mA	20,000
	AC	320 mA	20,000
48V	DC	100 mA	20,000
	AC	150 mA	20,000
120V	AC	60 mA ^①	20,000
240V	AC	30 mA ^①	20,000

LED Application Data

Type of Light	Color	Cluster LED Approximate Current, mA at Rated Volts	Cylindrical LED Approximate Current, mA at Rated Volts	Theoretical Lamp Life, Hours as Applied
Continuous/Flashing Stacklight LED				
12 Vac/Vdc	Red	92	92	100,000
	Amber	92	92	100,000
	Yellow	92	92	100,000
	Green	60	60	80,000
	Blue	60	60	60,000
	White	60	60	60,000
24 Vac/Vdc	Red	47	47	100,000
	Amber	47	47	100,000
	Yellow	47	47	100,000
	Green	59	59	80,000
	Blue	59	59	60,000
	White	59	59	60,000
48 Vac/Vdc	Red	25	25	100,000
	Amber	25	25	100,000
	Yellow	25	25	100,000
	Green	18	18	80,000
	Blue	31	31	60,000
	White	31	31	60,000
60 Vac/Vdc	Red	25	25	100,000
	Amber	25	25	100,000
	Yellow	25	25	100,000
	Green	18	18	80,000
	Blue	17	17	60,000
	White	17	17	60,000
120 Vac/Vdc	Red	24	24	100,000
	Amber	24	24	100,000
	Yellow	24	24	100,000
	Green	17	17	80,000
	Blue	16	16	60,000
	White	16	16	60,000

Note

^① Represents average current draw, 1.6A peak for 120V and 0.8A peak at 240V.

Mounting Instructions

Stacklight bases may be mounted without the use of an extension tube or mounting base. If additional height is required, choose

0.8–30 in (20–760 mm) extension tubes that fit between the mounting base and stacklight base. The extension tubes are threaded

with 3/4 in NPT threads, allowing for direct connection to conduit fittings or threaded holes without the use of a mounting base.

Base Mounting

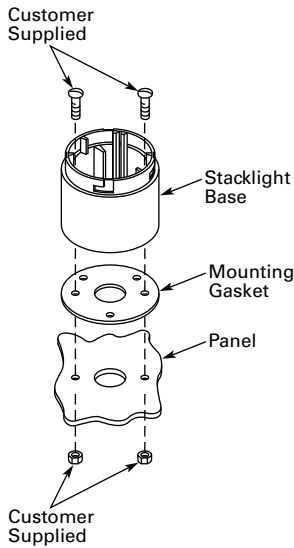

Utilizing Extension Tube and Mounting Base

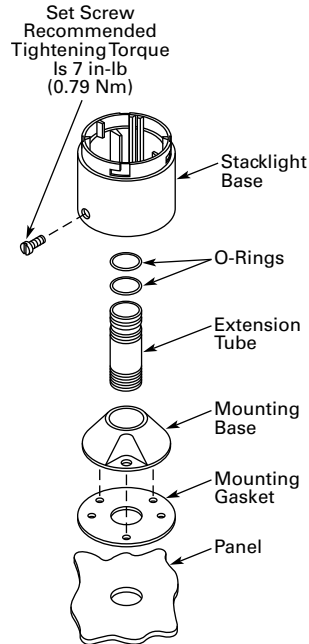

Utilizing Extension Tube and 3/4 In (19.1 mm) Conduit Hub

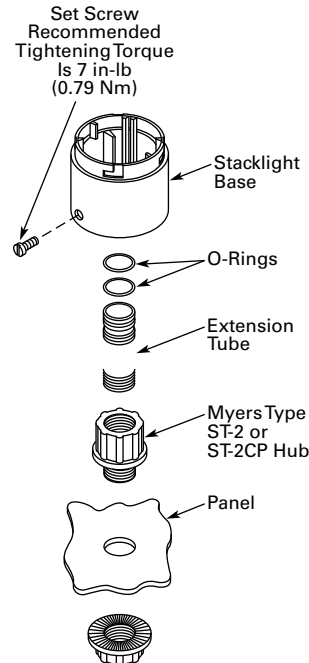

(Use Rubber-Jawed Pliers for Installation to Avoid Scratching the Black Anodized Coating)

Mounting Dimensions

Approximate Dimensions in Inches (mm)

Base Mounting

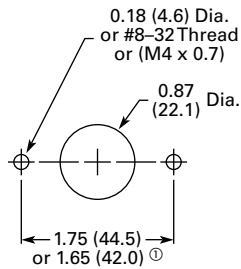

Three-Hole Mounting for E26S108

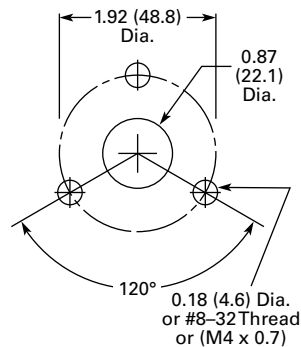

Four-Hole Mounting for E26S109

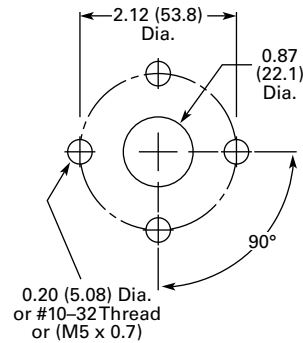

Conduit Hub for E26S104–3/4 In (19.1 mm)

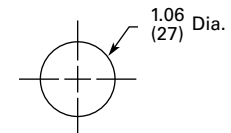

Note

① Stacklight base and gasket are supplied as standard with two sets of base mount holes. One set with center-to-center spacing of 1.75 in (44.5 mm) and another set with center-to-center spacing of 1.65 in (42 mm).

2.2

Stacklights

E26 Series

2

Dimensions

Approximate Dimensions in Inches (mm)

Standard and Flashing Bases ①

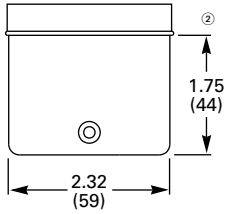

Alarm Units

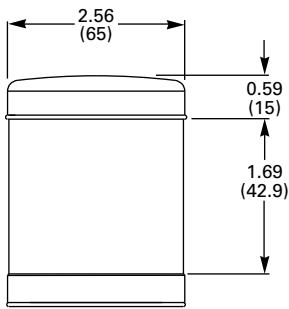

Assembled Extension Tubes

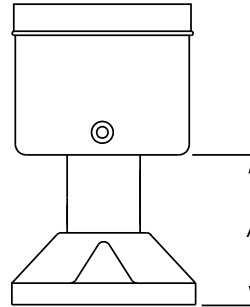

Tube Extension	Height A
0.79 (20)	1.77 (45)
6.30 (160)	7.28 (185)
14.17 (360)	15.16 (385)
29.92 (760)	30.91 (785)

Right Angle Extension Tubes

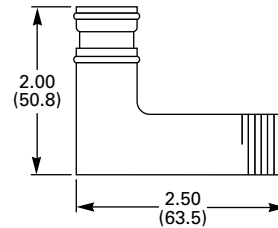

Notes

- ① Bases also suitable for mounting with extension tubes listed on [Page V7-T2-39](#).
- ② Mounting gasket and cover are supplied as standard with stacklight bases.

Approximate Dimensions in Inches (mm)

One-Light Unit Stacklight

Standard

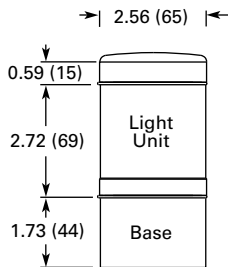

With Alarm

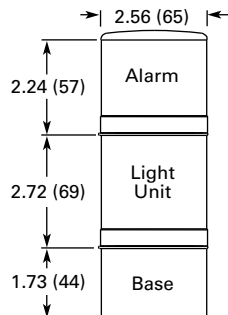

With Xenon Flasher

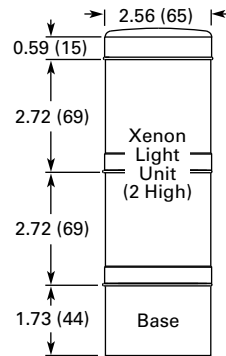

Two-Light Unit Stacklight

Standard

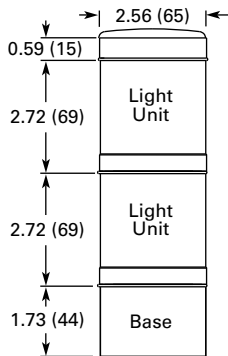

With Alarm

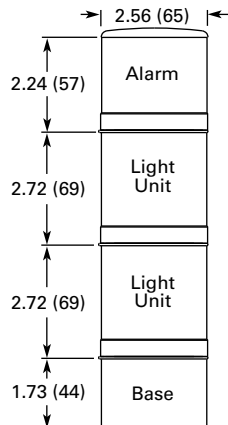

With Xenon Flasher

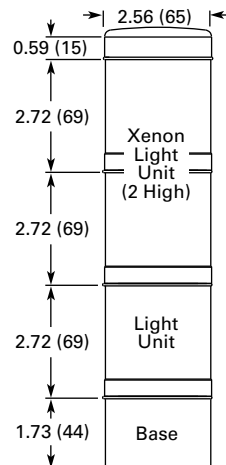

2.2

Stacklights

E26 Series

Approximate Dimensions in Inches (mm)

2

Three-Light Unit Stacklight

Standard

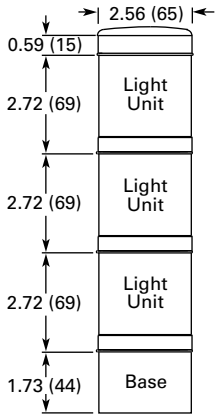

With Alarm

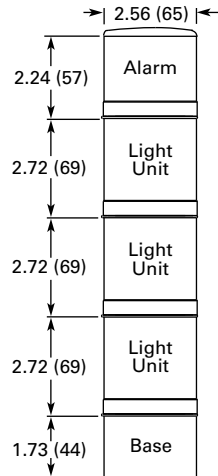

With Xenon Flasher

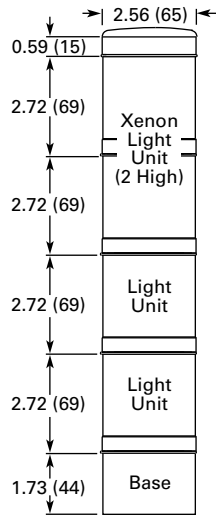

Light Modules

Standard

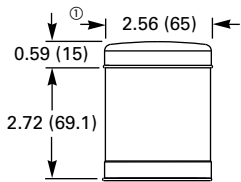

Xenon

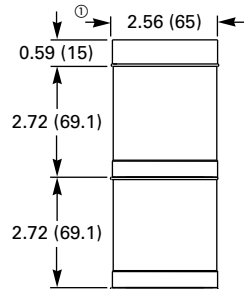

Note

① Cover included with stacklight base.